

**birzman**  
be boundless



## INDEX

|   |    |
|---|----|
| <i>Pumps</i> .....                              | 05 |
| <i>Bottles &amp; Cages</i> .....                | 21 |
| <i>Triathlon &amp; Saddle Rail Mounts</i> ..... | 25 |
| <i>Carriers</i> .....                           | 29 |
| <i>Multi-tools</i> .....                        | 35 |
| <i>Tool Boxes</i> .....                         | 39 |
| <i>Chain Tools</i> .....                        | 43 |
| <i>Workshop Tools</i> .....                     | 47 |







***A valve head  
with a TWIST...  
well and a PUSH.***

---

Three-legged base  
The backbone  
A slight eccentricity

---





## Push & Twist (Presta / Schrader)

- Intuitive, instant and secure.
- No damage to the valve core.
- No blow-offs under high pressure.
- Pressure bleed button (CAD) for ultimate accuracy.

Compatible with both Presta and Schrader under the same simple steps.

Insert, PUSH the collar down and TWIST it by one turn to secure engagement, then simply pull back the collar to disengage.

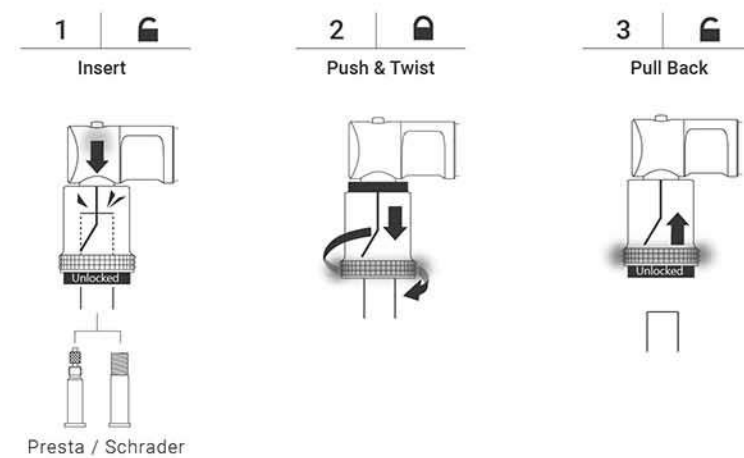

### Patented Technology

|                |                               |
|----------------|-------------------------------|
| United Kingdom | 2497163                       |
| United States  | US 9511636 B2 / US 9249914 B2 |
| Germany        | 102014106141                  |
| Taiwan         | I 498479 / I 489047           |
| China          | 1682615 / 2235061             |





**Maha Push & Twist II**

BM17-PT-2-S Silver

|                 |                                  |
|-----------------|----------------------------------|
| <b>Capacity</b> | 220 psi / 15 bar                 |
| <b>Head</b>     | Push & Twist (Presta / Schrader) |
| <b>Handle</b>   | CNC machined aluminium           |
| <b>Barrel</b>   | CNC machined aluminium           |
| <b>Base</b>     | CNC machined aluminium           |



**Grand Maha Push & Twist III**

BM17-PT-3-GA-GRAND Gunmetal

|                 |                                  |
|-----------------|----------------------------------|
| <b>Capacity</b> | 220 psi / 15 bar                 |
| <b>Head</b>     | Push & Twist (Presta / Schrader) |
| <b>Handle</b>   | Varnished wood                   |
| <b>Barrel</b>   | CNC machined aluminium           |
| <b>Base</b>     | CNC machined aluminium           |
| <b>Height</b>   | 744mm                            |



**Maha Push & Twist IV**

BM17-PT-4-GA Gunmetal

|                 |                                  |
|-----------------|----------------------------------|
| <b>Capacity</b> | 220 psi / 15 bar                 |
| <b>Head</b>     | Push & Twist (Presta / Schrader) |
| <b>Handle</b>   | Varnished wood                   |
| <b>Barrel</b>   | CNC machined aluminium           |
| <b>Base</b>     | High polymer                     |

**Flick-It (Presta / Schrader)**

- Compatible with Presta and Schrader with no switching required.
- A narrow and compact design for easy use even on smaller wheels.
- Innovative tightening structure allows for swift lever operation, while promoting secure engagement and quick disengagement.

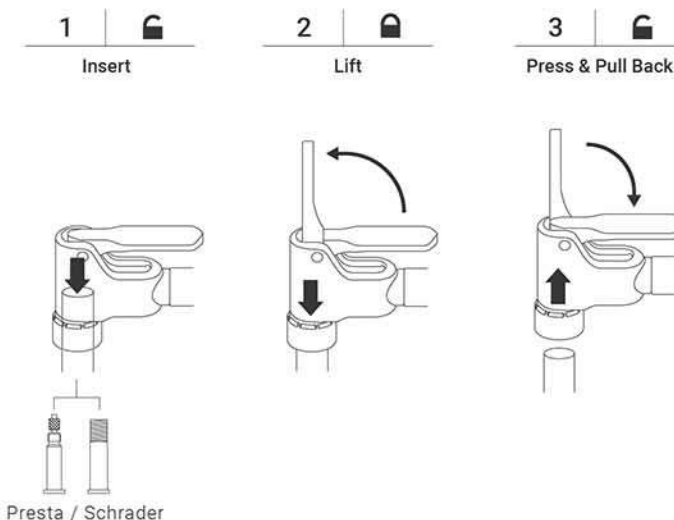

**Maha Flick-It V**

BM17-FI-5-220-S Silver  
BM17-FI-5-220-G Green

|                 |                              |
|-----------------|------------------------------|
| <b>Capacity</b> | 220 psi / 15 bar             |
| <b>Head</b>     | Flick-It (Presta / Schrader) |
| <b>Handle</b>   | High polymer                 |
| <b>Barrel</b>   | CNC machined aluminium       |
| <b>Base</b>     | High polymer                 |



**Maha Push & Twist V**

BM17-PT-5-K Black

|                 |                                  |
|-----------------|----------------------------------|
| <b>Capacity</b> | 220 psi / 15 bar                 |
| <b>Head</b>     | Push & Twist (Presta / Schrader) |
| <b>Handle</b>   | High polymer                     |
| <b>Barrel</b>   | CNC machined aluminium           |
| <b>Base</b>     | High polymer                     |

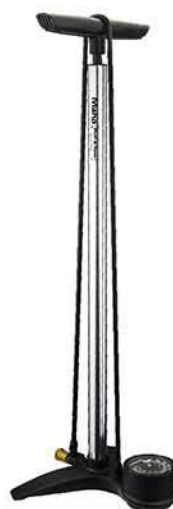

**Grand Maha Push & Twist V**

BM17-PT-5-GA-GRAND Gunmetal

|                 |                                  |
|-----------------|----------------------------------|
| <b>Capacity</b> | 220 psi / 15 bar                 |
| <b>Head</b>     | Push & Twist (Presta / Schrader) |
| <b>Handle</b>   | High polymer                     |
| <b>Barrel</b>   | CNC machined aluminium           |
| <b>Base</b>     | High polymer                     |
| <b>Height</b>   | 757mm                            |



**Maha Push & Twist Fatty**

BM17-PT-F-MTB Gunmetal

|                 |                                  |
|-----------------|----------------------------------|
| <b>Capacity</b> | 25 psi / 1.7 bar                 |
| <b>Head</b>     | Push & Twist (Presta / Schrader) |
| <b>Handle</b>   | Varnished wood                   |
| <b>Barrel</b>   | CNC machined aluminium           |
| <b>Base</b>     | CNC machined aluminium           |



**Maha Push & Twist MTB**

BM17-PT-MTB Silver

|                 |                                  |
|-----------------|----------------------------------|
| <b>Capacity</b> | 120 psi / 8.3 bar                |
| <b>Head</b>     | Push & Twist (Presta / Schrader) |
| <b>Handle</b>   | Varnished wood                   |
| <b>Barrel</b>   | CNC machined aluminium           |
| <b>Base</b>     | CNC machined aluminium           |



**Maha Push & Twist MTB II**

BM17-PT-MTB2 Black

|                 |                                  |
|-----------------|----------------------------------|
| <b>Capacity</b> | 120 psi / 8.3 bar                |
| <b>Head</b>     | Push & Twist (Presta / Schrader) |
| <b>Handle</b>   | High polymer                     |
| <b>Barrel</b>   | CNC machined aluminium           |
| <b>Base</b>     | High polymer                     |



Tubeless Inflator

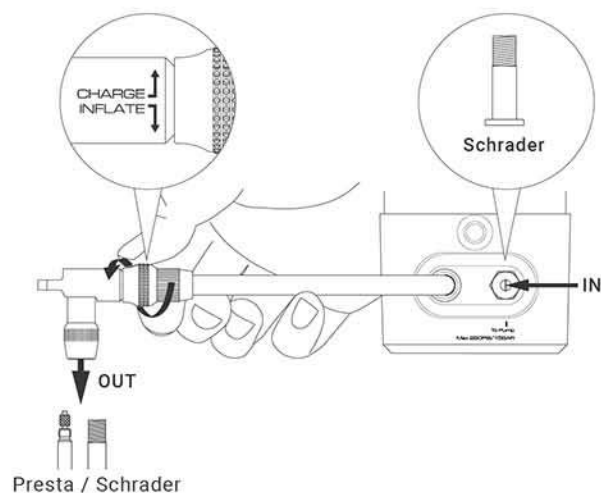

- Stores 1.2L of air up to 220psi.
- Compatible with all existing floor pumps.
- Threaded valve head for use with both Presta and Schrader.
- Rotational switch on head to control for immediate air release.
- Sleek cylindrical shape of great portability.

**Pump Up (Tubeless Inflator)**

BM17-PUMP-UP

|          |                                       |
|----------|---------------------------------------|
| Capacity | 220 psi / 15 bar (Max)                |
| Head     | Threaded (Presta / Schrader)          |
| Barrel   | CNC machined aluminium / High polymer |
| Size     | 12.3 x 8.1 x 36cm                     |
| Volume   | 1.2L                                  |

Mini Floor Pumps



**Tiny Tanker Push & Twist**

BM17-PT-TT-S

|          |                                  |
|----------|----------------------------------|
| Capacity | 220 psi / 15 bar                 |
| Head     | Push & Twist (Presta / Schrader) |
| Handle   | CNC machined aluminium           |
| Barrel   | CNC machined aluminium           |
| Base     | CNC machined aluminium           |
| Size     | 51 x 6 x 19cm                    |

**Horizons-Apogee**

BM16-ZC-HZ-S

|          |                                    |
|----------|------------------------------------|
| Capacity | 120 psi / 8.3 bar (with gauge)     |
| Head     | Snap-It Apogee (Presta / Schrader) |
| Handle   | CNC machined aluminium             |
| Barrel   | CNC machined aluminium             |
| Base     | High polymer / Stainless steel     |
| Size     | 30 x 4.2 x 2.5cm                   |
| Weight   | 230g                               |

**Horizons-Apogee Lite**

BM17-ZC-HZ-S-LITE

|          |                                    |
|----------|------------------------------------|
| Capacity | 120 psi / 8.3 bar                  |
| Head     | Snap-It Apogee (Presta / Schrader) |
| Handle   | CNC machined aluminium             |
| Barrel   | CNC machined aluminium             |
| Base     | High polymer / Stainless steel     |
| Size     | 30 x 4.2 x 2.5cm                   |
| Weight   | 178g                               |

*A burst of air,  
like a rush of blood to the head.*





# *Go head-to-head with punctures.*

---

*Sturdy*

*Packs a punch*

*For that just-get-me-home moment*

---







**Sheath-Apogee**

BM15-ZC-SHEATH — Silver

|                 |  |
|-----------------|--|
| <b>Capacity</b> | 160 psi / 11 bar   |
| <b>Head</b>     | Snap-It Apogee (Presta / Schrader)<br>Compatible with CO <sub>2</sub> cartridges |
| <b>Barrel</b>   | CNC machined aluminium   |
| <b>Size</b>     | 19.5 x 4.2 x 2.6cm   |
| <b>Weight</b>   | 120g   |
| <b>Includes</b> | 2 x 16g cartridges & 1 x neoprene grip   |
| <b>Patent</b>   | Taiwan M-448568  |

**Infinite Road (threaded) with CO<sub>2</sub>**

BM17-ZC-MN03-S — Silver

|                 |  |
|-----------------|--|
| <b>Capacity</b> | 160 psi / 11 bar                           |
| <b>Head</b>     | Threaded valve adapter (Presta / Schrader) |
| <b>Barrel</b>   | CNC machined aluminium                     |
| <b>Size</b>     | 25.5 x Ø2.5cm                              |
| <b>Weight</b>   | 147g                                       |
| <b>Includes</b> | 2 x 16g cartridges & 1 x neoprene grip     |
| <b>Patent</b>   | Taiwan M-450624                            |

**Infinite Road (threaded)**

BM17-ZC-MN02-S — Silver

|                 |                              |
|-----------------|------------------------------|
| <b>Capacity</b> | 160 psi / 11 bar             |
| <b>Head</b>     | Threaded (Presta / Schrader) |
| <b>Barrel</b>   | CNC machined aluminium       |
| <b>Size</b>     | 25.5 x Ø2.5cm                |
| <b>Weight</b>   | 140g                         |



**Infinite MTB (threaded) with CO<sub>2</sub>**

BM17-ZC-MN03-GA254 — Gunmetal

|                 |  |
|-----------------|--|
| <b>Capacity</b> | 90 psi / 6.2 bar                       |
| <b>Head</b>     | Threaded (Presta / Schrader)           |
| <b>Barrel</b>   | CNC machined aluminium                 |
| <b>Size</b>     | 25.5 x Ø3.2cm                          |
| <b>Weight</b>   | 175g                                   |
| <b>Includes</b> | 2 x 16g cartridges & 1 x neoprene grip |
| <b>Patent</b>   | Taiwan M-448568                        |

**Infinite MTB (threaded)**

BM17-ZC-MN02-GA254 — Gunmetal

|                 |                              |
|-----------------|------------------------------|
| <b>Capacity</b> | 90 psi / 6.2 bar             |
| <b>Head</b>     | Threaded (Presta / Schrader) |
| <b>Barrel</b>   | CNC machined aluminium       |
| <b>Size</b>     | 25.5 x Ø3.2cm                |
| <b>Weight</b>   | 170g                         |



**Velocity Road (threaded)**

BM17-ZC-MN01-S — Silver  
BM17-ZC-MN01-BK — Black

|                 |                              |
|-----------------|------------------------------|
| <b>Capacity</b> | 160 psi / 11 bar             |
| <b>Head</b>     | Threaded (Presta / Schrader) |
| <b>Barrel</b>   | CNC machined aluminium       |
| <b>Size</b>     | 19.3 x Ø2.8cm                |
| <b>Weight</b>   | 105g                         |

**Swift**

BM14-SWIFT — Silver

|                 |                              |
|-----------------|------------------------------|
| <b>Capacity</b> | 120 psi / 8.3 bar            |
| <b>Head</b>     | Threaded (Presta / Schrader) |
| <b>Barrel</b>   | CNC machined aluminium       |
| <b>Size</b>     | 19.5 x Ø2.6cm                |
| <b>Weight</b>   | 86g                          |

**Scope-Apogee**

BM15-ZC-SCOPE — Silver

|                 |                                    |
|-----------------|------------------------------------|
| <b>Capacity</b> | 120 psi / 8.3 bar                  |
| <b>Head</b>     | Snap-It Apogee (Presta / Schrader) |
| <b>Barrel</b>   | CNC machined aluminium             |
| <b>Size</b>     | 22 x 4 x 2.6cm                     |
| <b>Weight</b>   | 100g                               |

**Mini-Apogee**

BM14-ZC-MINI — Gunmetal

|                 |                                    |
|-----------------|------------------------------------|
| <b>Capacity</b> | 120 psi / 8.3 bar                  |
| <b>Head</b>     | Snap-It Apogee (Presta / Schrader) |
| <b>Barrel</b>   | CNC machined aluminium             |
| <b>Size</b>     | 13.6 x 2.3 x 3.8cm                 |
| <b>Weight</b>   | 75g                                |



**Velocity-Apogee MG**

BM14-ZC-MN04-GA234 — Gunmetal

|                 |                                    |
|-----------------|------------------------------------|
| <b>Capacity</b> | 90 psi / 6.2 bar (with gauge)      |
| <b>Head</b>     | Snap-It Apogee (Presta / Schrader) |
| <b>Barrel</b>   | CNC machined aluminium             |
| <b>Size</b>     | 22.3 x Ø3.1cm                      |
| <b>Weight</b>   | 146g                               |
| <b>Patent</b>   | Taiwan M-450624                    |

**Velocity MTB (threaded)**

BM17-ZC-MN01-S234 — Silver  
BM17-ZC-MN01-BK234 — Black

|                 |                                    |
|-----------------|------------------------------------|
| <b>Capacity</b> | 90 psi / 6.2 bar                   |
| <b>Head</b>     | Snap-It Apogee (Presta / Schrader) |
| <b>Barrel</b>   | CNC machined aluminium             |
| <b>Size</b>     | 18.3 x Ø3.1cm                      |
| <b>Weight</b>   | 124g                               |



## Activate Valve Function (Presta / Schrader)

- Releases CO<sub>2</sub> with a simple press down on the head.
- Allows for accurate controlled inflation.

Compatible with threaded CO<sub>2</sub> cartridges.

Patented Technology  
Taiwan I-534377

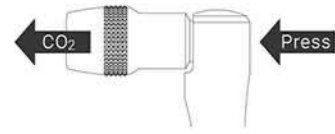

### Roar Canister 16g

- BM14-ZC-CO16-GA Gunmetal
- BM14-ZC-CO16-GN Green
- BM14-ZC-CO16-RD Red

**Material** CNC machined aluminium (valve head & canister)  
**Size** 5 x 11.4 x 2.9cm  
**Weight** 48g  
**Includes** 1 x 16g cartridge

### Roar 16g Set

- BM10-PO-AZC-01-GA Gray
- BM10-PO-AZC-01-G Green
- BM10-PO-AZC-01-K Black

**Material** CNC machined aluminium (valve head)  
PU (grip)  
**Size** 4.4 x 3 x 1.6cm (valve head)  
**Weight** 22g (valve head)  
**Includes** 3 x 16g cartridges

### E-Grip 16g Set

BM13-PO-AZC02-SET

**Material** CNC machined aluminium (valve head)  
Silicone (grip)  
**Size** 4.2 x 2.3 x 1.4cm (valve head)  
**Weight** 15g (valve head)  
**Includes** 1 x 16g cartridge

## Turn Pierce Function (Presta / Schrader)

- Controls for accurate inflation with build-in valve.
- Turn cartridge counter-clockwise to open the valve and release CO<sub>2</sub>; clockwise to close the valve.

Compatible with threaded CO<sub>2</sub> cartridges.

Patented Technology  
Taiwan M-448568

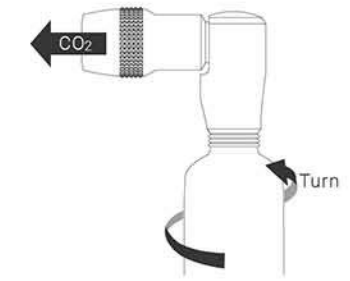

### Roar Canister 25g

BM14-ZC-CO25-GA Gunmetal

**Material** CNC machined aluminium (valve head & canister)  
**Size** 5.1 x 13.3 x 3.2cm  
**Weight** 67g  
**Includes** 1 x 25g cartridge

### Roar 25g Set

BM12-PO-CO202-K Black

**Material** CNC machined aluminium (valve head)  
Neoprene (grip)  
**Size** 4.4 x 3 x 1.6cm (valve head)  
**Weight** 22g (valve head)  
**Includes** 3 x 25g cartridges

### E-Grip 25g Set

BM13-PO-AZC02-SET25

**Material** CNC machined aluminium (valve head)  
Neoprene (grip)  
**Size** 4.2 x 2.3 x 1.4cm (valve head)  
**Weight** 15g (valve head)  
**Includes** 1 x 25g cartridge

*Immediate satisfaction.  
Instant gratification.*

## Uncage Repair Kit

BM17-UNCAGE-RP-KIT

- Functions**
- Attaches onto down/seat tubes or as an add-on to the Uncage Side Draw bottle cage.
  - Includes a supplementary Velcro strap to carry additional inner tube and tire levers.

**Size** 10 x 5.1 x 3.7cm  
**Weight** 158g  
**Includes** 1 x E-Grip valve head, 2 x 16g cartridges, 1 x Velcro strap

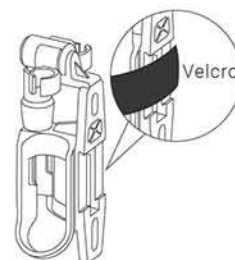

## CO<sub>2</sub> Cartridges (threaded)



16g x 3 PCS BM09-ZC-CO2-3PCS  
16g x 50 PCS BM11-ZC-CO2-50PCS  
25g x 3 PCS BM12-PO-CO202-3PCS  
25g x 35 PCS BM12-PO-CO202-35PCS





*Look mum,  
no air-loss!*

## Air-Lock

Designed to prevent air-loss when unscrewing from Schrader valves on the shock.

Patented Technology  
Taiwan I-493105



### Zama

BM13-TR-ZCSP02-SZM

|          |                        |
|----------|------------------------|
| Capacity | 300 psi / 20.7 bar     |
| Head     | Air-Lock valve         |
| Handle   | CNC machined aluminium |
| Size     | 20 x 2 x 2cm           |



### Macht

BM13-TR-ZCSP03-SMC

|          |                                       |
|----------|---------------------------------------|
| Capacity | 300 psi / 20.7 bar                    |
| Gauge    | 1" gauge with pressure release button |
| Head     | Air-Lock valve                        |
| Barrel   | CNC machined aluminium                |
| Size     | 24 x 2.5 x 3cm                        |



Pressure release button.

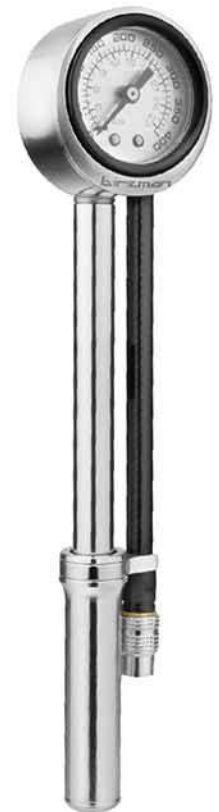

### Salut

BM17-SALUT

|          |   |
|----------|---|
| Capacity | 400 psi / 27.6 bar                      |
| Gauge    | 1.6" gauge with pressure release button |
| Head     | Air-Lock valve                          |
| Barrel   | CNC machined aluminium                  |
| Size     | 23 x 3.6 x 4.8cm                        |



Pressure release button.





# ***Top priority.***

---

*Essential  
Fundamental  
Crucial*

---





**Uncage Carbon R** (right hand use)  
BM18-UNCAGE-CBC-R

**Material** | 100% carbon fiber  
**Weight** | 22g

**Uncage Carbon L** (left hand use)  
BM18-UNCAGE-CBC-L

**Material** | 100% carbon fiber  
**Weight** | 22g

**Bottle Cage**

BM10-PO-NBC-01-W  White  
BM10-PO-NBC-01-K  Black

**Material** | High polymer  
**Weight** | 25g  
**Includes** | 3 interchangeable silicone pieces:

## Cageless Design

- Patented cleat-to-clip locking mechanism facilitates bottle accessibility and retention during rides.
- Flexible orientation of the clip brackets according to handedness.
- Compact cageless design preserves silhouette of the frame.

**Patented Technology**  
Taiwan M-527402

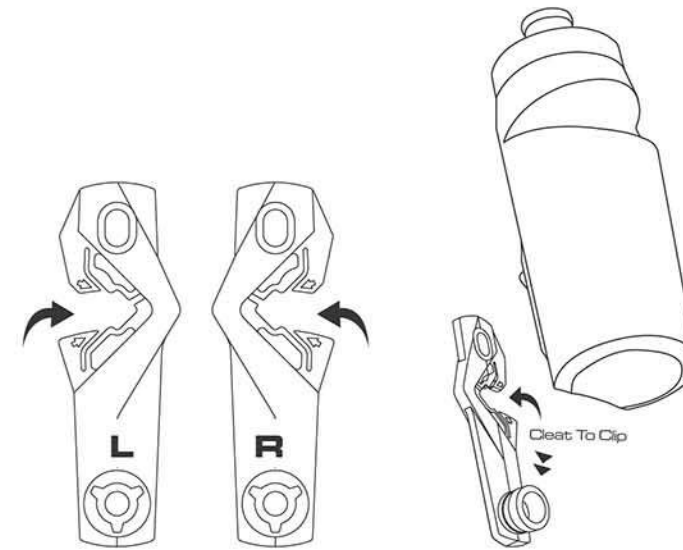

**BottleCleat**

BM17-BOTTLE-CLEAT-W  White  
BM17-BOTTLE-CLEAT-K  Black

**Material** | Body : FDA-approved food grade LDPE  
Spout : BPA-free TPR  
Cap : HDPR  
**Volume** | 650ml / 21oz  
**Temperature tolerance** | -30°C ~ 60°C / -22°F ~ 140°F  
**Weight** | 109g (incl.clip)  
**Size** | 19 x 9.2 x 7.6cm (incl.clip)



**Uncage Side Draw Bottle Cage**

BM17-UNCAGE-SIDE

**Material** | High polymer  
**Weight** | 62g

**Uncage Side Draw Bottle Cage Combo Kit**

BM17-UNCAGE-SIDE

**Material** | High polymer  
**Weight** | 220g  
**Includes** | 1 x Uncage Side Draw Bottle Cage  
1 x Uncage Repair Kit  
(1 x E-Grip valve head, 2 x 16g cartridges, 1 x Velcro strap)

**Uncage Bottle Cage**

BM17-UNCAGE

**Material** | High polymer  
**Weight** | 38g  
**Includes** | 1 x Velcro strap

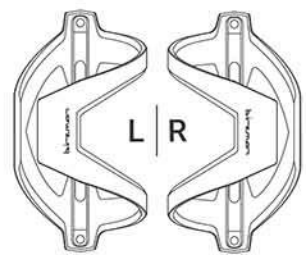

Symmetrical design allows for assembly according to handedness.

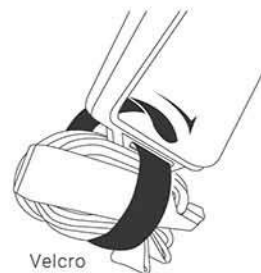
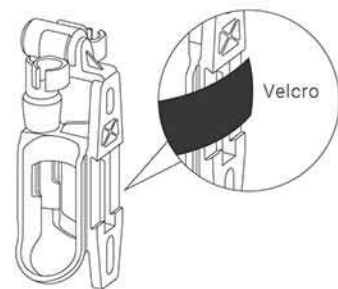

**Water Bottle**

BM10-PO-WB-01-W/K

**Material** | LDPE (toxic-free & odourless)  
**Volume** | 600ml / 20oz  
**Temperature tolerance** | -10°C ~ 70°C / 14°F ~ 158°F

**Water Bottle II**

BM10-PO-WB02-K

**Material** | LDPE (toxic-free & odourless)  
**Volume** | 600ml / 20oz  
**Temperature tolerance** | -10°C ~ 70°C / 14°F ~ 158°F

**Water Bottle III**

BM17-PO-WB-K

**Material** | LDPE (toxic-free & odourless)  
**Volume** | 650ml / 21oz  
**Temperature tolerance** | -10°C ~ 70°C / 14°F ~ 158°F





# *One bottle or two, that is the question.*

---

*Glutes, Quadriceps, Hamstrings, Flexors, Calves  
Hydration and calories  
Commitment and dedication*

---



## Rear Hydration System

- Modular structure with multiple mounting holes allows for different attachment possibilities and orientations
- The arms mount onto the saddle rail at two adjustable angles to fit saddles of different shapes.
- Streamlined aerodynamic framework minimises air resistance by hiding behind the rider's shadow.
- Constructed from 6061 aluminium with a maximum load of 2.5kg and a total weight of only 105g including hardware.



Optional Uncage Repair Kit attachment at rear end. (BM17-UNCAGE-RP-KIT)

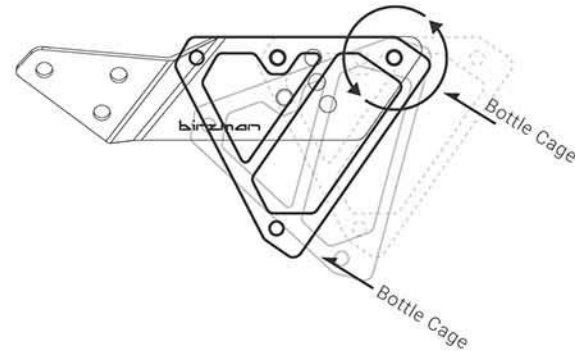
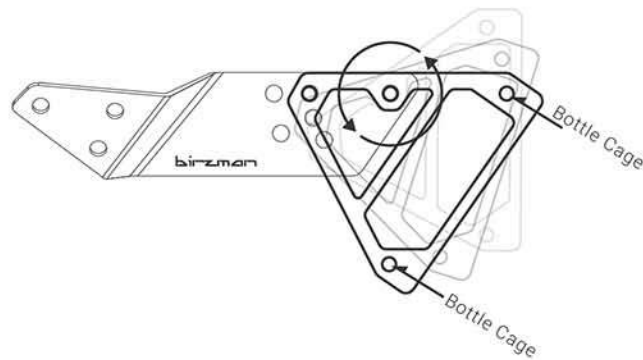

Carries two bottle cages on the sides at three angles when extended, plus additional accessories if needed.

Alternatively, bracket can be stowed to carry a single bottle cage at the rear end at two angles.



### Aeroman

BM17-AEROMAN

|          |                           |
|----------|---------------------------|
| Material | 6061 aluminium            |
| Size     | 170 x 72 x 68mm           |
| Weight   | 105g (including hardware) |
| Includes | 9mm carbon rail mounts    |

### Belly Tri

BM18-BAG-TTB-TRI

|           |  |
|-----------|--|
| Functions | <ul style="list-style-type: none"> <li>- Top tube bag</li> <li>- Attaches via three bolts or Velcro.</li> <li>- Detachable slab with bar-tacked elasticated strap for energy bar storage.</li> <li>- Tough rubber bottom prevents scratches or abrasions to the top tube.</li> </ul> |
|-----------|--|

|          |  |
|----------|--|
| Material | 300D Polyester (water repellent) with reflective details |
| Size     | 25 x 8.5 x 4cm   |



## Saddle Rail Mounts

- Modular saddle rail mounting system, compatible with GoPro on its own, or with additional accessories through extension mounts.
- The system allows the user to easily switch between different items and also move items between different bikes.



NEW

### Saddle Rail Mount + Bottle Mount

BM19-PO-RAM-BOTTLE

|           |   |
|-----------|---|
| Functions | <ul style="list-style-type: none"> <li>- The bottle mount adds one set of bottle cage holes to the base structure, providing space for items such as Bottle Cage, Repair Kit or others that share the same 64mm spacing.</li> <li>- Adjustable angle for the most comfortable reach.</li> </ul> |
|-----------|---|

|          |                                      |
|----------|--------------------------------------|
| Material | High Polymer, CNC machined aluminium |
| Size     | 80 x 12 x 19mm                       |



NEW

### Saddle Rail Mount + Bag Mount and Saddle Bag

BM19-PO-RAM-BAG

|           |  |
|-----------|--|
| Functions | <ul style="list-style-type: none"> <li>- Saddle bag with wide side-opening.</li> <li>- Features a quick-release bag mount for fast and easy installation and removal.</li> </ul> |
|-----------|--|

|          |                            |
|----------|----------------------------|
| Material | High polymer, EVA foam, PU |
| Size     | 15 x 8 x 6cm               |
| Capacity | 0.5L                       |







# ***Free up your pockets.***

---

*Never forget your essentials again*

*Extra visibility*

*When stopping for a cake break is not an option*

---



## Saddle Bags



### Elements I

BM16-PO-SB-EL1

|                  |  |
|------------------|--|
| <b>Functions</b> | Saddle bag<br>IPX5<br>Quick Assembly Brackets<br>Interfolding design<br>Compatible with 7mm saddle rails |
| <b>Material</b>  | ECO fabric (waterproof)<br>with reflective logo  |
| <b>Size</b>      | 9.5 x 7 x 4cm  |
| <b>Capacity</b>  | 0.25L  |
| <b>Patent</b>    | Taiwan M-458357  |

### Elements II

BM16-PO-SB-EL2

|                  |  |
|------------------|--|
| <b>Functions</b> | Saddle bag<br>IPX5<br>Quick Assembly Brackets<br>Interfolding design<br>Compatible with 7mm saddle rails |
| <b>Material</b>  | ECO fabric (waterproof)<br>with reflective logo  |
| <b>Size</b>      | 11.5 x 9 x 5cm   |
| <b>Capacity</b>  | 0.4L   |
| <b>Patent</b>    | Taiwan M-458357  |

### Elements III

BM17-PO-SB-EL3

|                  |  |
|------------------|--|
| <b>Functions</b> | Saddle bag<br>IPX5<br>Quick Assembly Brackets<br>Interfolding design<br>Compatible with 7mm saddle rails |
| <b>Material</b>  | ECO fabric (waterproof)<br>with reflective logo  |
| <b>Size</b>      | 16 x 10.5 x 6cm  |
| <b>Capacity</b>  | 0.8L   |
| <b>Patent</b>    | Taiwan M-458357  |



### Roadster I

BM13-PO-SB06-RD1

|                  |  |
|------------------|--|
| <b>Functions</b> | Saddle bag<br>Light attachment loop                        |
| <b>Material</b>  | 300D Polyester (water repellent)<br>with reflective straps |
| <b>Size</b>      | 13 x 7 x 4cm   |
| <b>Capacity</b>  | 0.3L   |



### Roadster II

BM13-PO-SB06-RD2

|                  |  |
|------------------|--|
| <b>Functions</b> | Saddle bag<br>Light attachment loop                        |
| <b>Material</b>  | 300D Polyester (water repellent)<br>with reflective straps |
| <b>Size</b>      | 15 x 8 x 5cm   |
| <b>Capacity</b>  | 0.4L   |



### M-Snug

BM13-PO-SB05-GAMS

|                  |  |
|------------------|--|
| <b>Functions</b> | Saddle bag<br>Light attachment loop<br>Quick Assembly Brackets<br>Compatible with 7mm saddle rails |
| <b>Material</b>  | 300D Polyester (water repellent)<br>with reflective straps   |
| <b>Size</b>      | 16 x 8 x 8cm   |
| <b>Capacity</b>  | 0.5L   |
| <b>Patent</b>    | Taiwan M-458357  |



### Zyklop Nip

BM10-PO-SB-01-K

|                  |                                     |
|------------------|-------------------------------------|
| <b>Functions</b> | Saddle bag<br>Light attachment loop |
| <b>Material</b>  | 600D Polyester (water repellent)    |
| <b>Size</b>      | 16.5 x 5 x 6.5cm                    |
| <b>Capacity</b>  | 0.3L                                |



### Zyklop Gike

BM10-PO-SB-02-K

|                  |                                     |
|------------------|-------------------------------------|
| <b>Functions</b> | Saddle bag<br>Light attachment loop |
| <b>Material</b>  | 300D Polyester (water repellent)    |
| <b>Size</b>      | 16.5 x 8 x 8cm                      |
| <b>Capacity</b>  | 0.5L                                |

## Top Tube Bags



### Belly S

BM13-PO-TTB03-GABS

|                  |                                     |
|------------------|-------------------------------------|
| <b>Functions</b> | Top tube bag<br>with rain cover     |
| <b>Material</b>  | 300D Polyester<br>(water repellent) |
| <b>Size</b>      | 13 x 6 x 4.5cm                      |



### Belly B

BM13-PO-TTB04-GABB

|                  |                                     |
|------------------|-------------------------------------|
| <b>Functions</b> | Top tube bag<br>with rain cover     |
| <b>Material</b>  | 300D Polyester<br>(water repellent) |
| <b>Size</b>      | 18 x 8 x 4.5cm                      |



### Belly R

BM14-BAG-TTB1

|                  |                                   |
|------------------|-----------------------------------|
| <b>Functions</b> | Rain resistant top tube bag       |
| <b>Material</b>  | 420D & 840D nylon<br>(waterproof) |
| <b>Size</b>      | 16.5 x 10 x 4cm                   |



### Zyklop Navigator III

BM13-PO-TTB02-KNG

|                  |   |
|------------------|---|
| <b>Functions</b> | Top tube bag<br>Touch screen window<br>(L15 x W8cm) |
| <b>Material</b>  | 300D Polyester<br>(water repellent)                 |
| <b>Size</b>      | 17 x 9 x 8cm  |

## Others



### Tool Bag

BM12-ATB04-K

|                 |                                     |
|-----------------|-------------------------------------|
| <b>Material</b> | 600D Polyester<br>(water repellent) |
| <b>Size</b>     | 36 x 27 x 4cm                       |



### Tool Bottle

BM11-AC-TB01-K

|                 |              |
|-----------------|--------------|
| <b>Material</b> | High polymer |
| <b>Size</b>     | 195 x Ø75mm  |
| <b>Capacity</b> | 750ml        |



### Feexcage

BM18-TB-FEEXCASE

|                 |              |
|-----------------|--------------|
| <b>Material</b> | EVA foam, PU |
| <b>Size</b>     | 200 x Ø72mm  |
| <b>Capacity</b> | 700ml        |



### Feexroll

BM18-SB-FEEXROLL

|                  |  |
|------------------|--|
| <b>Functions</b> | - Roll-up storage bag,<br>- Fits under the saddle rail<br>or in jersey pockets.            |
| <b>Material</b>  | 250D fabric<br>(waterproof)<br>with reflective logo<br>300D Polyester<br>(water repellent) |
| <b>Size</b>      | 27 x 27cm  |



### Anti-Slip Bundle Strap

BM17-STRAP

|                  |  |
|------------------|--|
| <b>Functions</b> | - Features a self-engaging Velcro side<br>and an anti-slip finish on the other side.<br><br>- Fixes inner tubes, CO2 cartridges,<br>tire levers and mini pumps onto the frame. |
| <b>Material</b>  | Nylon / TPE  |
| <b>Size</b>      | 3 x 40 cm / 1 1/4 x 16"  |



NEW

### Anti-Slip Bundle Strap with Snap-Fastener

BM19-STRAP-SF

|                  |   |
|------------------|---|
| <b>Functions</b> | - A self-engaging Velcro strap with<br>anti-slip finish on the other side.<br>- Fixes inner tubes plus tire lever<br>and/or spare parts under the saddle.<br>- Snap-fastener secures the strap on<br>saddle rail to facilitate item loading<br>and removal. |
| <b>Material</b>  | Nylon / TPE   |
| <b>Size</b>      | 3 x 40 cm / 1 1/4 x 16"   |



### FeexPouch

BM16-SB-FP

|                  |   |
|------------------|---|
| <b>Functions</b> | - Designed to fit in the jersey<br>back pocket when riding, or to<br>be assembled under the saddle<br>with the Velcro.<br>- IPX 4 |
| <b>Material</b>  | 420D / 840D nylon<br>(waterproof)   |
| <b>Size</b>      | 12 x 6.5 x 3.5cm  |
| <b>Capacity</b>  | 0.3L  |

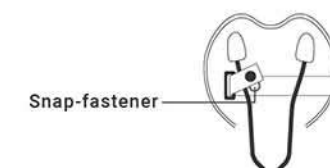
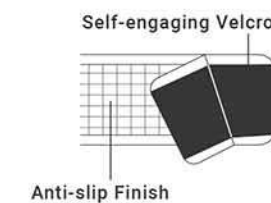





### Packman Handlebar Pack

BM18-BAG-HP-PKM

- Functions**
- Three-point attachment reinforces overall stability.
  - EVA foam pads offer protection against abrasion and ensure compatibility with different handlebar types.
  - Roll-top IPX5 waterproof carrier allows for flexible capacity adjustments.
  - Two additional straps for further attachment possibilities.

**Material** 420D / 600D high density fabric (water repellent and abrasion resistant)  
250D ECO fabric (waterproof)

**Size** 50 x Ø24cm

**Capacity** 9.5L (waterproof carrier)

**NEW**

### Packman Saddle Pack with Waterproof Carrier

BM19-BAG-SB-WPF-PKM

- Functions**
- Adjustable side fastening straps.
  - Roll-top IPX5 waterproof carrier provides improved rain/mud protection and allows for flexible capacity adjustments.
  - Features a saddle rail rack to increase stability and minimise rattle.

**Material** 420D / 600D high density fabric (water repellent and abrasion resistant)  
250D ECO fabric (waterproof)

**Size** 50 x Ø24cm

**Capacity** 9.5L (waterproof carrier)



Saddle rail rack



### Packman Travel Saddle Pack

BM17-BAG-SB-PKM

- Functions**
- Adjustable side fastening straps.
  - Elastic upper cords for additional storage capacity.
  - Two extra straps for further attachment possibilities.

**Material** 420D / 600D high density fabric (water repellent and abrasion resistant)

**Size** 50 x 18 x 16cm

**Capacity** 6L

### Packman Travel Bottle Pack

BM17-BAG-BO-PKM

- Functions**
- Compatible with bottles up to 750ml in volume, or 9cm in diameter and 25cm in height.
  - Bar-tacked strap offers multiple Velcro position adjustments.

**Material** 210D / 600D high density fabric (water repellent and abrasion resistant)

**Size** Ø9.5 x 15cm (collapsed) / 20cm (extended)



The romantic idea of temporarily leaving the noisy



### Packman Travel Top Tube Pack

BM17-BAG-TTB-PKM

- Functions**
- Straightforward Velcro fastening onto top tube.
  - Zipped-up interior compartment, 3 external pockets.

**Material** 420D / 600D high density fabric (water repellent and abrasion resistant)

**Size** 26 x 10 x 16cm

**Capacity** 0.8L

### Packman Travel Frame Pack - Planet

BM17-BAG-FR-PL

- Functions**
- Straightforward Velcro fastenings onto frames of different sizes.
  - Two extra straps for further attachment possibilities.

**Material** 420D / 600D high density fabric (water repellent and abrasion resistant)

**Size** 38 x 12 x 5cm

**Capacity** 3L



### Packman Travel Frame Pack - Satellite

BM17-BAG-FR-SA

- Functions**
- Straightforward Velcro fastenings onto frames of different sizes.
  - One extra strap for further attachment possibilities.

**Material** 420D / 600D high density fabric (water repellent and abrasion resistant)

**Size** 25 x 28 x 5cm

**Capacity** 2.5L

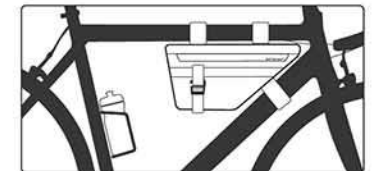

### Modular design

Combination possibilities according to requirement:

Install individually or together for a total storage capacity of 5.5L.





*“Is it weird to  
admire the looks  
of a multi-tool?”*

-road.cc

---

*Forged then CNC'd chrome vanadium  
Central pivot, individually drilled keys, pleasingly smooth action  
Fits in your hand, folds into a small package, or a dog #mrfeexman*

---





**E-Version 5**

BM09-PO-AFM-04-S Silver  
BM09-PO-AFM-04-K Black

|                  |  |
|------------------|--|
| <b>Functions</b> | Hex keys 4/5/6mm<br>Torx key T25<br>Crosshead screwdriver #1 |
| <b>Material</b>  | Body : Aluminium<br>Tools : CrV                              |
| <b>Size</b>      | 69 x 29 x 10mm   |
| <b>Weight</b>    | 58g  |



**NEW**  
**E-Version 10**

BM19-PO-AFM-10-S Silver  
BM19-PO-AFM-10-K Black

|                  |  |
|------------------|--|
| <b>Functions</b> | Hex keys 2.5/3/4/5/6(L-shaped)/8mm<br>Torx key T25<br>Crosshead screwdriver #1<br>Flathead screwdriver 4.5<br>Chain rivet extractor (8-12 speed, 3/32" single speed) |
| <b>Material</b>  | Body : Aluminium<br>Tools : CrV<br>Chain Tool : Alloy Steel  |
| <b>Size</b>      | 68.5 x 50 x 14 mm  |
| <b>Weight</b>    | 119g   |



**E-Version 15**

BM09-PO-AFM-05-S Silver  
BM09-PO-AFM-05-K Black

|                  |   |
|------------------|---|
| <b>Functions</b> | Hex keys 2/2.5/3/4/5/6/8mm<br>Torx key T25<br>Crosshead screwdriver #1<br>Flathead screwdriver 4.5<br>Chain rivet extractor (9-12 speed)<br>Spoke wrenches 3.2/4.3/4.4/Mavic® |
| <b>Material</b>  | Body : Aluminium<br>Tools : CrV<br>Chain Tool : Alloy Steel   |
| <b>Size</b>      | 69 x 50 x 16mm  |
| <b>Weight</b>    | 128g  |



**Cicada C10**

BM11-PO-FM16-C10

|                  |  |
|------------------|--|
| <b>Functions</b> | Hex keys 2/2.5/3/4/5/6/8mm<br>Torx key T25<br>Crosshead screwdriver #1<br>Flathead screwdriver 4.5<br>Chain rivet extractor (9-12 speed)<br>Tire lever |
| <b>Material</b>  | Body : Carbon<br>Tools : CrV<br>Chain Tool : Aluminium   |
| <b>Size</b>      | 70 x 47 x 20mm   |
| <b>Weight</b>    | 110g   |



**Diversity 17**

BM16-FM-D17-MK

|                  |  |
|------------------|--|
| <b>Functions</b> | Hex keys 2/2.5/3/4/5/6/8mm<br>Torx key T25<br>Crosshead screwdriver #1<br>Flathead screwdriver 4.5<br>Chain rivet extractor (8-12 speed, 3/32" single speed)<br>Spoke wrenches 3.2/3.4<br>Chain hook<br>Tire Lever Set<br>CO2 valve head (Presta/Schrader) |
| <b>Material</b>  | Body : High polymer<br>Tools : CrV<br>Chain tool : Alloy Steel   |
| <b>Size</b>      | 100 x 46 x 24mm  |
| <b>Weight</b>    | 178g   |



**E-Version 20**

BM09-PO-AFM-09-S Silver  
BM09-PO-AFM-09-K Black

|                  |   |
|------------------|---|
| <b>Functions</b> | Hex keys 2/2.5/3/4/5/6/8mm<br>Torx key T25<br>Crosshead screwdriver #1<br>Flathead screwdriver 4.5<br>Chain rivet extractor (9-12 speed)<br>Spoke wrenches 3.2/3.4/4.3/4.4/Mavic®<br>Tire lever<br>Disc adjuster<br>Knife<br>Can opener |
| <b>Material</b>  | Body : Aluminium<br>Tools : CrV<br>Chain Tool : Alloy Steel   |
| <b>Size</b>      | 73 x 57 x 16mm  |
| <b>Weight</b>    | 165g  |



**NEW**  
**Stainless S10**

BM19-FM-S10-SK Black

|                  |  |
|------------------|--|
| <b>Functions</b> | Hex keys 2.5/3/4/5/6(L-shaped)/8mm<br>Torx key T25<br>Crosshead screwdriver #1<br>Flathead screwdriver 4.5<br>Chain rivet extractor (8-12 speed, 3/32" single speed) |
| <b>Material</b>  | Body : Stainless Steel<br>Tools : CrV<br>Chain Tool : Alloy steel  |
| <b>Size</b>      | 68.5 x 50 x 14 mm  |
| <b>Weight</b>    | 147g   |



**NEW**  
**Stainless S12**

BM18-FM-S12-SK Black

|                  |  |
|------------------|--|
| <b>Functions</b> | Hex keys 2/2.5/3/4/5/6/8mm<br>Torx key T25<br>Crosshead screwdriver #1<br>Flathead screwdriver 4.5<br>Chain rivet extractor (9-12 speed)<br>Tire lever |
| <b>Material</b>  | Body : Stainless Steel<br>Tools : CrV<br>Chain Tool : Aluminium  |
| <b>Size</b>      | 70 x 47 x 20mm   |
| <b>Weight</b>    | 158g   |

**M-Torque 5Nm**

- Pocket torque wrench.
- Button clicks when force reaches the preset 5Nm indicating that the bolt has been tightened.
- No calibration or maintenance needed.
- Rated to 10000 clicks.
- IPX4



**M-Torque 4**

BM15-MTORQUE-4

|                  |  |
|------------------|--|
| <b>Functions</b> | Hex keys 4/5mm (5Nm torque alert function)<br>Torx key T25 (interchangeable to the torque end)<br>Flathead screwdriver 4.5 |
| <b>Material</b>  | Body : Alloy Steel<br>Tools : CrV  |
| <b>Size</b>      | 93 x 34 x 18mm   |
| <b>Weight</b>    | 90g  |



**M-Torque 10**

BM15-MTORQUE-10

|                  |   |
|------------------|---|
| <b>Functions</b> | Hex keys 4/5mm (5Nm torque alert function)<br>Torx key T25 (5Nm torque alert function)<br>Hex keys 2/3/8mm/L-shaped 6mm<br>Flathead screwdriver 4.5<br>Crosshead screwdriver #1<br>Chain rivet extractor (8-12 speed, 3/32" single speed) |
| <b>Material</b>  | Body : Alloy Steel<br>Tools : CrV<br>Chain Tool : Alloy Steel   |
| <b>Size</b>      | 93 x 57 x 18mm  |
| <b>Weight</b>    | 170g  |



**M-Torque Ranger**

BM16-MTORQUE-RA

|                  |  |
|------------------|--|
| <b>Functions</b> | Hex keys 3/4/5mm<br>Torx key T25<br>Flathead screwdriver 4.5             |
| <b>Material</b>  | Body : High Polymer<br>Bits : S2 tool steel<br>Tire Lever : High Polymer |
| <b>Size</b>      | 112 x 36 x 25mm  |
| <b>Weight</b>    | 113g   |





## **“The squad”, curated by Birzman.**

---

*Tidy  
Compact  
Comprehensive*

---



**birzman**  
be boundless

"The quality is amazing, almost to the point you feel bad using them on your bike."  
- VitalMTB

Tool Box



**Essential Tool Box**

BM17-ESSENTIAL-BOX

|           |                  |
|-----------|------------------|
| Functions | 13 pieces        |
| Size      | 400 x 240 x 80mm |
| Weight    | 2.62kg           |

- 01 Torx® Key Set T10/T25/T30
- 02 Hex Key Set 1.5/2/2.5/3/4/5/6mm
- 03 Hex Key 8mm
- 04 ½" Drive
- 05 Tire Lever Set
- 06 Shimano® HG Cassette 12-spline Ø23.4mm
- 07 Disc Brake Gap Indicator
- 08 Hollowtech® II B.B. Tool 16-notch Ø44mm
- 09 Spoke Wrench 12G/13G/14G/15G / Shimano® 4.3/4.4
- 10 Chain Rivet Extractor ½" and ⅝" single speed, 5-12 speed
- 11 Pedal Wrench 15mm
- 12 Chain Whip 7-12 speed
- 13 Flathead Screwdriver 5.5, Crosshead Screwdriver PH2



**NEW**

**Travel Tool Box**

BM19-TRAVEL-BOX

|           |                  |
|-----------|------------------|
| Functions | 20 pieces        |
| Size      | 460 x 280 x 80mm |
| Weight    | 4.35kg           |

- 01 Torx® Key Set T10/T15/T20/T25/T27/T30/T40
- 02 Hex Key Set 1.5/2/2.5/3/4/5/6/8/10mm
- 03 Chain Wear Indicator 0.5% / 0.75% / 1%, single to 12 speed
- 04 Feextube Patch Kit 3 x adhesive patches, 1 x tire boot
- 05 Tire Lever Set
- 06 B.B. Socket Shimano® Cartridge 20-notch Ø31.6mm
- 07 Lockring Socket Shimano® HG 12-spline Ø23.4mm, Ø5mm center pin.
- 08 Lockring Socket Shimano® MF & Campagnolo® 12-spline Ø22.7mm
- 09 Universal Crank Puller ISIS® Drive, Octalink® and square tapered crank arms
- 10 Housing and Cable Cutter Features an integrated awl for restoring housing ends.
- 11 B.B. Socket Hollowtech II™ 16-notch Ø44mm.
- 12 Socket Wrench ½" Dr.
- 13 Crank Arm Cap Tool 8-notch Hollowtech II™ and 16mm internal hex SRAM® crank caps.
- 14 Spoke Wrench 12G / 13G / 14G / 15G / Shimano® 4.3 & 4.4
- 15 Damselfly Universal Chain Rivet Extractor 5-12 speed, ⅝" & ½" single speed chains
- 16 Pedal Wrench 15mm
- 17 Chain Whip 7-12 speed, equipped with a fixed-gear lockring wrench.
- 18 Screwdriver Flathead 5.5
- 19 Screwdriver Crosshead #2
- 20 Combination Wrench 8 & 10mm



**NEW**

**Studio Tool Box**

BM19-STUDIO-BOX

|           |                   |
|-----------|-------------------|
| Functions | 37 pieces         |
| Size      | 470 x 370 x 130mm |
| Weight    | 8.2kg             |

- 01 Torx® Key Set T10/T15/T20/T25/T27/T30/T40
- 02 Hex Key Set 1.5/2/2.5/3/4/5/6/8/10mm
- 03 Chain Wear Indicator 0.5% / 0.75% / 1%, single to 12 speed
- 04 Bladed Spoke Grip 1.0-2.0mm wide bladed spokes
- 05 Tire Lever Set
- 06 B.B. Socket Shimano® Cartridge 20-notch Ø31.6mm
- 07 Lockring Socket Shimano® HG 12-spline Ø23.4mm, Ø5mm center pin.
- 08 Lockring Socket Shimano® MF & Campagnolo® 12-spline Ø22.7mm
- 09 Universal Crank Puller ISIS® Drive, Octalink® and square tapered crank arms
- 10 Housing and Cable Cutter Features an integrated awl for restoring housing ends.
- 11 B.B. Socket Hollowtech II™ 16-notch Ø44mm.
- 12 Socket Wrench ½" Dr.
- 13 Crank Arm Cap Tool 8-notch Hollowtech II™ and 16mm internal hex SRAM® crank caps
- 14 Spoke Wrench 12G / 13G / 14G / 15G / Shimano® 4.3 & 4.4
- 15 Damselfly Universal Chain Rivet Extractor 5-12 speed, ⅝" & ½" single speed chains
- 16 Pedal Wrench 15mm
- 17 Chain Whip 7-12 speed, equipped with a fixed-gear lockring wrench.
- 18 Screwdriver Flathead 5.5
- 19 Screwdriver Crosshead #2
- 20 Combination Wrench 8 & 10mm

- 21 File
- 22 Link Pliers For use to assemble or remove masterlinks.
- 23 Bit Socket T30 ½" Dr.
- 24 Hex Socket 14mm ½" Dr.
- 25 Hex Socket 15mm ½" Dr.
- 26 Shifting Spanner 0-33mm
- 27 Disc Brake Piston Press
- 28 Rotor Truing Fork
- 29 Disc Brake Gap Indicator
- 30 Threadless Saw Guide For Ø1", 1½" and 1¾", steel and carbon tubes.
- 31 Valve Core Tool For Presta / Schrader valve cores and Presta valve extenders.
- 32 Threadless Nut Setting Tool For Ø1 - 1½" threadless headset systems.
- 33 Diagonal Pliers 6"
- 34 Radio Pliers 6"
- 35 Chainring Nut Wrench Features 9 & 10mm hex wrenches.
- 36 Dead Blow Hammer 12"
- 37 Tape Measure .3m/10ft



# *From BMX to 12 speed to Campagnolo®.*

---

*Hey Siri, what is the difference between a dragonfly and a damselfly?  
#inspiredbynature from the beginning  
Is it a chain tool, chain breaker, or chain rivet extractor?*

---





## Rear Rivet System

- Interchangeable cradle for use with 11/12 speed chains.
- Features a gate mechanism compatible with Campagnolo®11 speed chains ensuring precise positioning when setting replacement rivet.

**Patented Technology**  
Taiwan I-381913

### Dragonfly Evolution

BM09-DF-S

|                  |  |
|------------------|--|
| <b>Functions</b> | Compatible with 9-12 speed chains.   |
| <b>Material</b>  | Handle : CNC machined 6061 aluminium<br>Body : CNC machined 6061 aluminium<br>Pin : Special steel S2 |
| <b>Size</b>      | 175 x 105 x 28mm   |
| <b>Weight</b>    | 285g   |



## Smart Cradle System

Adjustable cradle system securely fits chains of different sizes, allowing the tool pin to drive out the rivet quickly and precisely.

**Patented Technology**  
Taiwan I-435778



### Damselfly Universal

BM12-PO-ACH04-K

|                  |   |
|------------------|---|
| <b>Functions</b> | Compatible with 5-12 speed;<br>$\frac{3}{32}$ " and $\frac{1}{8}$ " single speed chains.          |
| <b>Material</b>  | Handle : CNC machined 6061 aluminium<br>Body : CNC machined 6061 aluminium<br>Pin : S2 tool steel |
| <b>Size</b>      | 160 x 100 x 22mm  |
| <b>Weight</b>    | 242g  |



### Lighter Universal

BM16-ACH06-LU

|                  |   |
|------------------|---|
| <b>Functions</b> | - Compatible with 5-12 speed;<br>$\frac{3}{32}$ " and $\frac{1}{8}$ " single speed chains.<br>- Equipped with a chain hook. |
| <b>Material</b>  | Handle : Alloy Steel<br>Body : CNC machined 6061 aluminium<br>Pin : S2 tool steel   |
| <b>Size</b>      | 145 x 70 x 21mm   |
| <b>Weight</b>    | 215g  |



## Innovative Spring System

Innovative spring steel immediately and securely binds with the chain, holding it in place for the tool pin to drive out the rivet easily.

### Light-Er

BM12-PO-ACH05-WD

|                  |  |
|------------------|--|
| <b>Functions</b> | Compatible with 8-12 speed chains.                                 |
| <b>Material</b>  | Handle : Alloy steel<br>Body : Varnished wood<br>Pin : Alloy steel |
| <b>Size</b>      | 105 x 47 x 13mm  |
| <b>Weight</b>    | 76g  |



### Lighter Atom

BM16-ACH06-LA

|                  |   |
|------------------|---|
| <b>Functions</b> | - Compatible with 8-12 speed chains.<br>- Equipped with a chain hook. |
| <b>Material</b>  | Handle : Alloy steel<br>Body : High polymer<br>Pin : Alloy steel      |
| <b>Size</b>      | 108 x 49 x 13mm   |
| <b>Weight</b>    | 80g   |



### Feexpin

BM09-PO-ACH-01-K

|                  |  |
|------------------|--|
| <b>Functions</b> | - Compatible with 9-12 speed chains.<br>- Equipped with chain hook.<br>- 4/5mm hex keys. |
| <b>Material</b>  | Handle : Alloy steel<br>Body : Alloy steel<br>Pin : Alloy steel                          |
| <b>Size</b>      | 85 x 40 x 11mm   |
| <b>Weight</b>    | 98g  |



### Damselfly

BM11-PO-DF02-S

|                  |   |
|------------------|---|
| <b>Functions</b> | Compatible with 9-12 speed chains.  |
| <b>Material</b>  | Handle : CNC machined 7075 aluminium<br>Body : CNC machined 7075 aluminium<br>Pin : Alloy steel |
| <b>Size</b>      | 100 x 55 x 10mm   |
| <b>Weight</b>    | 40g   |



### Link Pliers

BM15-ST-LR01-K

|                  |  |
|------------------|--|
| <b>Functions</b> | For use when assembling or removing masterlinks. |
| <b>Material</b>  | Alloy steel / High polymer                       |
| <b>Size</b>      | 6,5"   |



NEW

### Chain Assembly Fixer

BM18-PO-ACA-01-K

|                  |  |
|------------------|--|
| <b>Functions</b> | Holds the chains in place during assembly.                   |
| <b>Material</b>  | CNC machined 6061 aluminium / Stainless steel / High polymer |



## Innovative Spring System

Innovative spring steel immediately and securely binds with the chain, holding it in place for the tool pin to drive out the rivet easily.

### Light-Er

BM12-PO-ACH05-WD

|                  |  |
|------------------|--|
| <b>Functions</b> | Compatible with 8-12 speed chains.                                 |
| <b>Material</b>  | Handle : Alloy steel<br>Body : Varnished wood<br>Pin : Alloy steel |
| <b>Size</b>      | 105 x 47 x 13mm  |
| <b>Weight</b>    | 76g  |



### Lighter Atom

BM16-ACH06-LA

|                  |   |
|------------------|---|
| <b>Functions</b> | - Compatible with 8-12 speed chains.<br>- Equipped with a chain hook. |
| <b>Material</b>  | Handle : Alloy steel<br>Body : High polymer<br>Pin : Alloy steel      |
| <b>Size</b>      | 108 x 49 x 13mm   |
| <b>Weight</b>    | 80g   |



### Chain Wear Indicator

BM10-ST-CC-02

|                  |  |
|------------------|--|
| <b>Functions</b> | - Checks the degree of chain wear and stretch.<br>- Indications : 0.75% / 1.0% |
| <b>Material</b>  | Stainless steel  |



NEW

### Chain Wear Indicator I

BM10-ST-CC-01

|                  |  |
|------------------|--|
| <b>Functions</b> | - Checks the degree of chain wear and stretch.<br>- Integrated chain hooks hold chains in place during assembly or repair.<br>- Compatible with derailleur chains from single to 12 speed.<br>- Indications : 0.5/ 0.75/ 1.0%. |
| <b>Material</b>  | Stainless steel  |



### Chain Wear Indicator II

BM17-ST-CC-02

|                  |  |
|------------------|--|
| <b>Functions</b> | - Checks the degree of chain wear and stretch.<br>- Compatible with all derailleur chains.<br>- Indications : 0.25/ 0.5/ 0.7/ 0.8/ 1.0%. |
| <b>Material</b>  | CNC machined 6061 aluminium  |





# Less swearing, more whistling.

---

*Bombproof solid steel construction*

*Tight tolerance*

*Let's be new best friends*

---







**Specialist Lockring Wrench**

Shimano® HG™  
BM11-ST-BBW02-KSH

**Functions** Compatible with Shimano® HG™ & SRAM Cassettes, Shimano® Center Lock, or other similar 12-spline  $\varnothing$ 23.4mm lockrings.

**Material** CrMo / TPR



**Specialist B.B. Wrench**

Shimano® Cartridge  
BM11-ST-BBW02-KSC

**Functions** Compatible with Shimano® Cartridge or other similar 20-notch  $\varnothing$ 31.6mm bottom brackets.

**Material** CrMo / TPR



**Specialist Lockring Wrench**

Shimano® MF™ & Campagnolo®  
BM11-ST-BBW02-KCC

**Functions** Compatible with Shimano® MF™ Freewheels, Campagnolo® Cassettes, BB and Rotors, or other similar 12-spline  $\varnothing$ 22.6mm lockrings.

**Material** CrMo / TPR



**Specialist B.B. Wrench**

Hollowtech II™  
BM11-ST-BBW02-K

**Functions** Compatible with Hollowtech II™ or other 16-notch  $\varnothing$ 44mm external bearing bottom bracket cups.

**Material** CrMo / TPR



**Specialist Chain Whip**

BM11-ST-FWT02-K9  
**Functions** - Compatible with 7-12 speed chains.  
- Equipped with a fixed-gear locking wrench.

**Material** CrMo / TPR



**Specialist 15mm Pedal Wrench**

BM11-ST-PDW02-K  
**Functions** 15mm pedal wrench.  
**Material** K5 steel / TRP



**Specialist Wrench Extension Bar**

BM11-ST-MHE-K  
**Functions** Modular wrench extension bar  
**Material** CrMo / TPR



product design award

2012 GOLD



**Specialist 4PCS Wrench Set**

BM11-ST-SW02-MB  
**Includes** Specialist B.B. Wrench Hollowtech II™  
Specialist Lockring Wrench Shimano® HG™  
Specialist Chain Whip  
Specialist 15mm Pedal Wrench  
Specialist Wrench Extension Bar

**NEW**  
**1/2" Ratchet Wrench Set**

BM19-ST-RCW02-S8  
**Functions** 1/2" Dr. ratchet wrench with 72-teeth.  
**Material** CrV  
**Includes** Seven sockets:  
T30 Bit/15mm Hex/8mm Hex Bit/1/2" Extension Bar/  
B.B. (Shimano® Cartridge)/Lockring (Shimano® MF™)  
Lockring 5mm (Shimano® HG™)



**Combination Wrench Set**

BM14-CW-GT-SET  
**Functions** - 8/9/10/11/12/13/14/15mm.  
- Features a ratcheting box end with 72-teeth.  
**Material** CrV





**Torque Wrench 10-60Nm**

BM18-TW-10-60NM

**Functions** - 1/2" Dr.  
- 10-60Nm

**Material** Alloy Steel

**Size** 14.5"



**Torque Wrench 3-15Nm**

BM10-ST-TW-01-K

**Functions** - 1/4" Dr.  
- 3-15 Nm

**Includes** Seven bit sockets:  
3/4/5/6/8mm hex / T25 / 90mm extension bar.

**Material** Alloy steel (wrench)  
CrV (bits)

**Size** 8" (wrench)



**Torque Driver 4Nm**

BM16-TD-4NM

**Functions** - 1/4" Dr.  
- 4Nm

**Includes** Four bits: 3/4/5mm hex / T25

**Material** S2 tool steel (bits)

**Size** 52 x 78 x 23mm (driver)



**Torque Driver 5Nm**

BM16-TD-5NM

**Functions** - 1/4" Dr.  
- 5Nm

**Includes** Four bits: 3/4/5mm hex / T25

**Material** S2 tool steel (bits)

**Size** 80 x 65 x 23mm (driver)



**Torque Driver 6Nm**

BM16-TD-6NM

**Functions** - 1/4" Dr.  
- 6Nm

**Includes** Four bits: 3/4/5mm hex / T25

**Material** S2 tool steel (bits)

**Size** 80 x 65 x 23mm (driver)



**T-Bar Set (with Wrenches)**

BM11-PO-ATB03-K

**Functions** - 2/2.5/3/4/5/6/8/10mm & T25.  
- Two way ball-point hex/Torx®keys.

**Material** SNCMV / high polymer (wrenches)  
SPHC (stand)

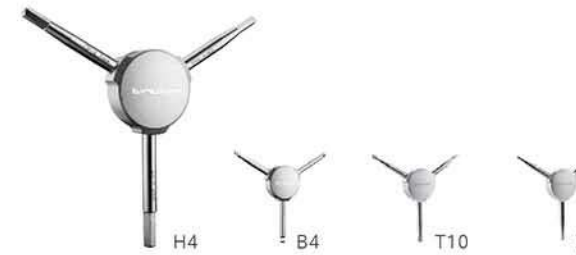

**Y-Grip**

**Functions** Features an ergonomic design for improved leverage.

**Material** CNC machined aluminium / CrV (bits)

**Size** 131 x 113 x 18mm

**Weight** 110g

**Options :**

|                                |                |
|--------------------------------|----------------|
| 4/5/6mm hex key set            | BM14-YGRIP-H4  |
| 4/5/6mm ball point hex key set | BM14-YGRIP-B4  |
| T10/T25/T30mm Torx®key set     | BM14-YGRIP-T10 |
| 2/2.5/3mm hex key set          | BM14-YGRIP-H2  |



**Hex Key Set**

BM12-ST-ATC02-K

**Functions** - Features an anti-slip case.  
- Tools drive out with easy rotation.  
- 1.5/2/2.5/3/4/5/6/8/10mm

**Material** S2 tool steel



**NEW**  
**Hex Key Multitool**

BM19-ST-HEX-8

**Functions** - Fold-up hex key set with comfortable grip.  
- 90° right angle design provides maximum torque.  
- 1.5/2/2.5/3/4/5/6/8 mm

**Material** PP, TPR, CrV

**Size** 114 x 36.5 x 25mm

**Weight** 152g

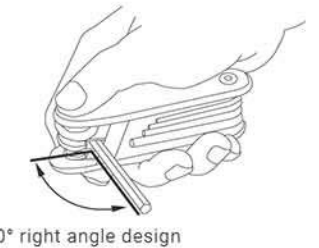

90° right angle design



**Torx® Key Set**

BM12-ST-ATC03-K

**Functions** - Features an anti-slip case.  
- Tools drive out with easy rotation.  
- T10/T15/T20/T25/T27/T30/T40/T45/T50

**Material** S2 tool steel



**NEW**  
**Torx® Key Multitool**

BM19-ST-TORX-8

**Functions** - Fold-up Torx® key set with comfortable grip.  
- 90° right angle design provides maximum torque.  
- T9/T10/T15/T20/T25/T27/T30/T40

**Material** PP, TPR, SNCMV

**Size** 114 x 36.5 x 25mm

**Weight** 149g

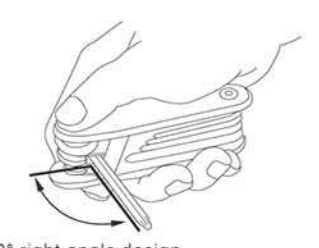

90° right angle design





*Familiar tool,  
unfamiliarily high quality.*

---

*[\(Click Here\)](#) Add to wishlist*

*Make an impression*

*Buy less, choose well, quality not quantity.*

---





### B.B. Tapping & Facing Kit

BM15-BBTFK

- Functions**
- Compatible with both English and Italian dimensions.
  - 1.37" x 24 TPI right hand bushing - English
  - 1.37" x 24 TPI left hand bushing - English
  - 36mm x 24 TPI right hand bushing - Italian



### Bearing Cup Press

BM15-BC-PRESS

- Functions**
- Presses headset cups, bearings and bearing cups.
  - Compatible with 1", 1-1/8", 1-1/4", and 1-1/2" headset cups, one-piece crank bottom bracket cups.
  - Quick-release design for fast tool installation and removal.
- Material** Alloy steel
- Size** 455 x 290 x 50 mm
- Includes** Two pcs of BB inserts, for press fit bearings OD 45mm / ID 30mm.



### Bearing Cup Press II

BM16-BCP02

- Functions**
- Presses headset cups, bearings and bearing cups.
  - Compatible with 1", 1-1/8", 1-1/4", and 1-1/2" headset cups; BB30, PF30, BB90, BB86 and BB92, and one-piece crank bottom bracket cups.
  - Diameter of thread: 10mm (≈ 3/8")
- Material** Alloy steel
- Size** 280 x 230 x 60mm



### Bottom Bracket Installation Tool For BB30 / PF30

BM16-BBIT-30

- Functions**
- Compatible with BB30 & PF30; 6805 (25 x 37 x 7mm) and 6806 (30 x 42 x 7mm) BB bearings.
- Material** Alloy steel
- Size** 280 x 38mm



### Pin Wrench

BM15-BBFW-K

- Functions**
- Double-sided and adjustable design.
  - For use on bottom brackets, crank, freewheels.
  - Diameter of pin: 2.2/2.8mm.
- Material** Alloy steel / High polymer
- Size** 155mm



### B.B. Socket BSA30 / 386

BM18-BB-BSA30/386

- Functions**
- 1/2" Dr. socket.
  - Compatible with Rotor® BSA 30, SRAM® DUB, RaceFace® Cinch, Zipp® Vuma, Hawk Racing® BB3086 or other 12-notch Ø46.5mm external bearing bottom bracket cups.
  - Compatible with FSA® EVO 386 or other 16-notch Ø48.5mm external bearing bottom bracket cups.
- Material** CNC machined 7075-T6 aluminium



### B.B. Socket Hollowtech II™

BM13-ABB-S

- Functions**
- 1/2" Dr. socket.
  - Compatible with Hollowtech II™ or other 16-notch Ø44mm external bearing bottom bracket cups.
- Material** Alloy steel



### B.B. Socket Adapter BB9000 / BBR60

BM14-BB-ADAPTER

- Functions**
- Compatible with BB9000 / BBR60
  - Slides into Birzman B.B. Socket (Hollowtech II™).
- Material** CNC machined hardened steel



NEW

### B.B. Socket Hollowtech II™

BM18-ABB-S

- Functions**
- 1/2" Dr. socket
  - Compatible with Shimano® Hollowtech II™ or other 16-notch Ø44mm external bearing bottom bracket cups, and 16-notch rotor disc lockrings (incl. E-thru axle hubs).
  - Fits Shimano® BB Tool Adaptors TL-FC24 & TL-FC25.
- Material** CNC machined hardened steel



### B.B. Socket Shimano® Cartridge

BM08-RWH-SBBT

- Functions**
- 1/2" Dr. socket.
  - Compatible with Shimano® Cartridge or other similar 20-spline Ø31.6mm bottom brackets.
- Material** Alloy steel



### Hook Wrench

BM17-DS-CBBW

- Functions**
- Single hook / hook spanner with 3 notches / 24mm hex wrench.
- Material** SPHC-P
- Size** 300mm



### Headset and BB Wrench with Hookspanner

BM17-DS-BB-HEAD-WH

- Functions**
- 16/30/32/36/40 mm
- Material** SPHC-P
- Size** 300mm





NEW

**Lockring Socket**

Bosch® Ø60 (Gen 1)

BM19-ABB-BO60

- Functions**
- ½" Dr.
  - Compatible with Bosch Classic\* (MY pre-2014) drive units with 8-notch Ø60mm chainring lockrings.

**Material** CNC machined alloy steel



NEW

**Lockring Socket**

Bosch® Ø50 (Gen 2)

BM19-ABB-BO50

- Functions**
- ½" Dr.
  - Compatible with Bosch® Active (MY 2014-17), Performance and Performance CX Line (MY 2014 onwards) drive units with 8-notch Ø50mm chainring lockrings.

**Material** CNC machined alloy steel



NEW

**Lockring Socket**

Bosch® Ø43 (Gen 3)

BM19-ABB-BO43

- Functions**
- ½" Dr.
  - Compatible with Bosch® Active Line and Active Line Plus (MY 2017 onwards) drive units with 8-notch Ø43mm chainring lockrings.

**Material** CNC machined alloy steel



NEW

**Lockring Socket**

Shimano® STEPS Ø39

BM19-ABB-SMN39

- Functions**
- ½" Dr.
  - Compatible with Shimano® STEPS E6000 drive units with 16-notch Ø39mm chainring lockrings.

**Material** CNC machined alloy steel



NEW

**Lockring Socket**

Shimano® STEPS Ø54

BM19-ABB-SMN54

- Functions**
- ½" Dr.
  - Compatible with Shimano® STEPS E5000/E7000/E8000 drive units with 16-notch Ø54mm chainring lockrings.

**Material** CNC machined alloy steel



NEW

**Lockring Socket**

Brose® Ø43

BM19-ABB-BR-E

- Functions**
- ½" Dr.
  - Compatible with Brose® drive units with 8-notch Ø43mm chainring lockrings.

**Material** CNC machined alloy steel



NEW

**Lockring Socket**

Panasonic® Ø62

BM19-ABB-PANA

- Functions**
- ½" Dr.
  - Compatible with Panasonic® drive units with 6-notch Ø62mm chainring lockrings and bottom bracket cups with Torque Sensor.

**Material** CNC machined alloy steel



NEW

**Lockring Socket**

Yamaha® PW-X Ø46

BM19-ABB-YA-46

- Functions**
- ½" Dr.
  - Compatible with Yamaha® PW-X drive units with 8-notch Ø46mm chainring lockrings.

**Material** CNC machined alloy steel



NEW

**Lockring Socket**

Yamaha® PW 36mm Hex

BM19-ABB-YA-36

- Functions**
- ½" Dr.
  - Compatible with Yamaha® PW drive units with 36mm hex chainring lockrings.

**Material** CNC machined alloy steel

**Crank Arm Cap Tool**

BM14-CAT-S

- Functions**
- Compatible with Hollowtech II® cranksets or other 8-notch crank arm caps.

**Material** CNC machined 6061 aluminum

**Crank Arm Cap Tool II**

BM18-CAT-2

- Functions**
- Compatible with Hollowtech II® or other 8-notch crank arm caps / SRAM® RaceFace® or other 16mm internal hex crank caps.
  - Features 6mm hex holes on both sides.

**Material** CNC machined 6061 aluminum

**Chainring Nut Wrench**

BM13-CNW-S

- Functions**
- Immobilises slotted chainring nuts when installing or removing bolts.
  - 9/10mm hex wrenches.

**Material** Alloy Steel / High polymer

**Universal Crank Puller**

BM14-UCP-S

- Functions**
- Compatible with ISIS® Drive, Octalink® and square tapered crank arms.
  - Equipped with a spindle driver with self-rotating tip to facilitate crank arm extraction.
  - Features a protection ring to help prevent damages to the crank arm thread from over-threading.

**Material** Alloy steel

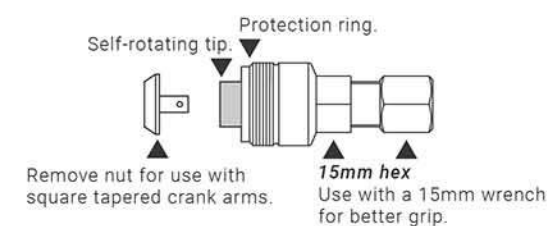
**Pedal Wrench**

BM14-PW-K

- Functions**
- 15mm pedal wrench.

**Material** Hardened steel / TPR

**Size** 12"

**Repical (Mock Pedal)**

BM12-ST-DP01-WD

- Functions**
- Temporarily replaces the pedal when making adjustments during bike assembly.

**Material** Alloy steel / Varnished wood

**Size** 4.7"





**Chain Whip**

BM14-CW-K

**Functions** - Compatible with 7-12 speed sprockets.  
- Equipped with fixed-gear lockring wrench.

**Material** Hardened steel / TPR

**Size** 295mm



**Sprocket Remover**

BM17-SPRO-WH

**Functions** Compatible with 7-12 speed sprockets.

**Material** SPHC steel / High polymer

**Size** 300mm



**Belt Drive Sprocket Remover**

BM17-BELT-SPRO-WH

**Functions** Compatible with most major belt drive sprockets.

**Material** SPHC steel / High polymer

**Size** 300mm



**Lockring Socket Shimano® MF & Campagnolo®**

BM08-RWH-FWR

**Functions** - 1/2" Dr. socket.  
- Compatible with Shimano® MF™ Freewheels, or other similar 12-spline Ø22.7mm lockrings.  
- Compatible with Campagnolo® Cassettes, BB and Rotors.

**Material** Alloy steel



**Lockring Socket 5mm Shimano® HG™**

BM08-RWH-SHGC02

**Functions** - 1/2" Dr. socket.  
- Features Ø5mm center pin.  
- Compatible with Shimano® HG™ & SRAM® Cassettes, Shimano® Center Lock, or other similar 12-spline Ø23.4mm lockrings.

**Material** Alloy steel



**1X Freewheel Socket**

BM14-BFR-S

**Functions** - 1/2" Dr. socket.  
- Compatible with BMX, single speed freewheels or other similar 4-notch Ø41mm lockrings.

**Material** Alloy steel



**Lockring Socket 12mm Shimano® HG™**

BM16-LOCK-RING-RM12

**Functions** - 1/2" Dr. socket.  
- Features Ø12mm center pin for thru axel hubs.  
- Compatible with Shimano® HG™ & SRAM® Cassettes, Shimano® Center Lock, or other similar 12-spline Ø23.4mm lockrings.

**Material** Alloy steel (socket) / Aluminium (center pin)



**Head Tube Reaming & Facing Kit**

BM15-HT-RFK

**Functions** Compatible with 1" and 1 1/8" conventional headset systems. Includes 30 & 34mm reamers.



**12" Hacksaw**

BM14-HKB-C

**Functions** - Adjustable blade tension.  
- Equipped with 12" x 24T saw blade  
- Compatible with Birzman 12" Carbon Saw Blade (BM14-HCS-C).

**Material** HSS Bi-Metal (saw blade)



**12" Carbon Saw Blade**

BM14-HCS-C

**Functions** - Compatible with 12" Hacksaws.  
- For use on most carbon tubes.

**Material** Carbon steel



**Hacksaw 10" x 24T**

BM14-HKS-B

**Functions** Equipped with with a 10" x 24T saw blade.

**Material** HSS Bi-Metal (saw blade)



**Threadless Saw Guide**

BM13-TSG-K

**Functions** - Guides the blade to ensure a precise cut on tubes ranging from 1 to 1 1/4".  
- Reversible panel to accommodate both 1.2mm (steel) and 2mm (carbon) saw blades.

**Material** Alloy steel / High polymer



**Tube Cutter**

BM08-FTC

**Functions** Compatible with Ø6 to 38mm (1/4" - 1 1/2") copper, brass, aluminium and steel tubing.

**Material** Alloy steel (body) / High polymer (handle) / High Speed Steel (blade) / SK2 (deburrer)

**Includes** Replacement blade / deburrer inside handle.





### Crown Race Puller

BM15-CRP

**Functions** - 45° chamfered edge for greater engagement with crown race.  
 - Compatible with rigid and suspension forks, 1 to 1½" crown races, with steering columns ranging from 120 to 375mm (4.7-14.7") in length.  
 - Designed to be secured onto repair stand.

**Material** Hardened steel (blades) / Alloy steel / High polymer

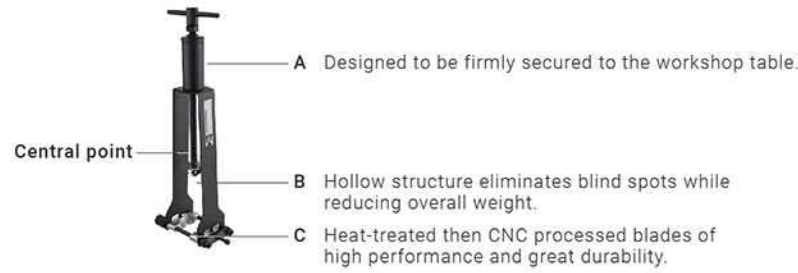

### Crown Race Removal Tool

BM09-ST-AHC-01-K

**Functions** - 45° chamfered edge for greater engagement with crown race.  
 - Compatible with rigid and suspension forks, 1 to 1½" crown races.

**Material** Hardened steel (blades)



### Crown Race Setting Tool

BM08-CRST

**Material** Alloy steel

**Includes** 1" and 1½" inserts.



### 1¼" Insert

BM11-ST-CRST02-1.25

**Functions** Additional 1¼" insert for Birzman Crown Race Setting Tool (BM08-CRST).

**Material** Alloy steel



### 1½" Insert

BM11-ST-CRST02-1.5

**Functions** Additional 1½" insert for Birzman Crown Race Setting Tool (BM08-CRST).

**Material** Alloy steel



### Threadless Nut Setting Tool

BM14-TNST

**Functions** For use on installing star-fangled nuts on 1 to 1½" threadless headset systems.

**Material** Alloy steel / Aluminium



### Frame Alignment Gauge

BM15-FAG

**Functions** Compatible with bikes of all sizes and types including Fat- and E-Bikes with broader frames, wider wheels and hub motor.

**Material** Alloy steel / Stainless steel / High polymer



### Universal Head Cup Remover

BM16-HUCR

**Functions** - Adjustable fan-out dimension (∅28.58-38.1mm).  
 - Compatible with 1 to 1½" headset cups, BB30 bearings and PF30 bearing cups.

**Material** CrMo

**Patent** Taiwan I570011



**Head Cup Remover** 1", 1¼" & 1½" | BM08-HCR-28.6  
 1¼" & 1½" | BM15-HCR

**Material** CrMo



### Fork End & Frame Alignment Gauge Set

BM16-FFAGS

**Functions** - Aligns and corrects fork and rear frame dropouts.  
 - Features removable bushings.  
 - Compatible with forks and frames with a span of 100-160mm between dropouts.

**Material** Alloy steel / High polymer



### Derailleur Hanger Configuration Gauge

BM16-DHCG

**Functions** - Measures and aligns derailleur hangers.  
 - Features sliding brackets with precise meter scales.  
 - Compatible with 20"-29" wheels.

**Material** Alloy steel / Aluminium / High polymer



### Handlebar Holder

BM16-HAN-BAR-HOLDER

**Functions** - Prevents handlebar and front wheel rotation.  
 - Compatible with handlebars up to ∅32mm and top tubes up to ∅50mm.

**Material** Alloy steel / High polymer





### Housing and Cable Cutter

BM11-ST-CC02-K

- Functions** | Features an integrated awl for restoring cut housing ends.
- Material** | Hardened Steel / High polymer
- Size** | 7.5"
- Patent** | Taiwan M-409139

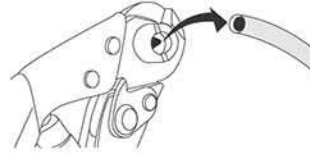

### Cable Pliers

BM16-CAB-PL

- Functions** | - Pulls cables tight when adjusting brakes and derailleurs.  
- Features a thumb lock for single-handed operation.
- Material** | Alloy steel / High polymer
- Size** | 8"

### Clam (Disc Brake Calliper Alignment Tool)

BM09-CL-S (3pcs/set)

- Functions** | Creates an equal space between disc brake pads and rotor for calliper adjustments.
- Material** | Stainless steel
- Size** | 58mm

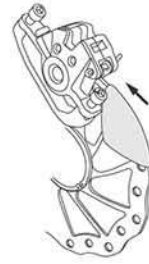

### Rotor Truing Fork

BM09-RO-ARF-01-K

- Functions** | Features two different slot lengths.
- Material** | Alloy steel / High polymer
- Size** | 10"

### Disc Brake Piston Press

BM14-DBPP-K

- Functions** | Features a wedge-shaped end of 23mm in width.
- Material** | Hardened steel / TPR
- Size** | 9"



**NEW**

### Rotor Wear Indicator

BM19-ROTOR-CC

- Functions** | - Quickly checks the degree of rotor wear to determine a replacement.  
- Laser engraved minimum thickness (lower wear limit) indications as per suggestion of each rotor manufacturer.  
- Covers 90% of mainstream rotor specifications.  
- Double-sided, designed for both left and right hand use.

**Material** | CNC machined 7075 aluminium

**Size** | 110 x 29 x 10mm

**Weight** | 225g

- Indications** | Shimano® / Hope® (Ø180-205 mm) : Min.TH 1.5 mm  
SRAM® : Min.TH 1.55 mm  
Magura® : Min.TH 1.8 mm  
Tektro® & TRP® e-bike (TH 2.3 mm) : Min.TH 2.0 mm

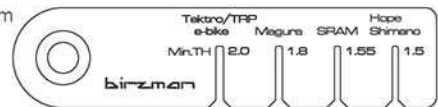
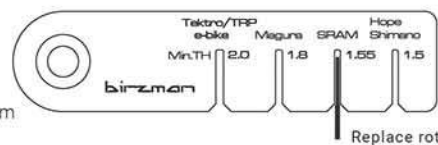

Find the corresponding manufacturer mark, insert worn braking surface of rotor into the slot. If it fits, replace the rotor with a new one.

**NEW**

### Internal Cable Routing Kit

BM19-ITL-CAB-RT

- Functions** | - Magnetic tool that aids internal cable routing by guiding cables through the frame.  
- Compatible with cables, housings/hoses and wires.  
- Fabric covered tip protects frame from scratches.  
- Built-in awl helps restore cut housing ends for easier attachment with adapter / easier cable insertion.

**Includes** | 4 x individual adapters, 1 x lead wire, 1 x flexible extension

**Material** | Aluminium, Alloy steel (adapters)

**Size** | Ø21x120mm



### Tubes & Tires



### Valve Core Tool (Presta / Schrader)

BM15-VCL01

- Functions** | - For the removal and installation of valve cores.  
- Features a 5mm flat wrench for removing Presta valve extenders.

**Material** | CNC machined 7075 aluminium

**Size** | 11.5 x 60mm

### Valve Extender (With Tool)

20mm | BM13-PO-AVE-20-SET

40mm | BM13-PO-AVE-40-SET

80mm | BM13-PO-AVE-80-SET

- Functions** | Attaches to Presta valves with the valve core removed.

**Material** | CNC machined aluminium

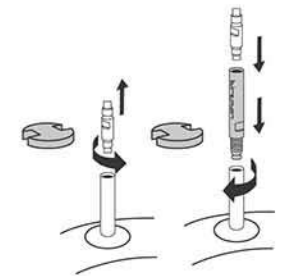

### Valve Extender With Valve Core 40mm / 80mm

40mm | BM16-VEC-40

80mm | BM16-VEC-80

- Functions** | Attaches to Presta valves with the valve core on.

**Material** | CNC machined aluminium

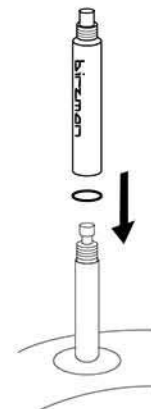





### Tire Seater

BM17-ST-TIRE-SEATER

- Functions**
- Features anti-slip jaws for swift and easy removal of stubborn tires.
  - Adjustable to various tire widths.
- Material** CrMo (jaws) / High polymer (handle)
- Size** 14"



### Wedge Wedge

BM12-ST-WG02-K

- Functions**
- Multi-purpose tire lever for tire removal and rim strip adjustments.
  - Insert molded to increase strength and prevent damaging rims.
  - Ergonomically designed to improve grip and leverage.
- Material** CrMo / High polymer
- Size** 210 mm (Wedge Wedge) / 120mm (tire lever)



### Tire Lever Set

BM09-WG-SET (3pcs/set)  
BM09-WG-90PCS (90pcs)

- Functions** Features an additional air release knob for use on Schrader valves.
- Material** Hardened POM
- Size** 120 mm
- Weight** 13g (1pcs)

### Feextube

BM09-PO-AFT-91-K (1set)  
BM09-PO-AFT-02-K (30 sets/box)

- Functions**
- Patch kit for puncture repairs.
  - Eraser-like stainless scuffer with comfortable grip.
  - Features a PP panel for storing chain rivet and masterlinks.
- Material** Stainless steel / High polymer
- Size** 74 x 43 x 12mm
- Weight** 20g (1set)
- Includes** 3 x adhesive patches, 1 x tire boot.



Eraser-like scraping tool



### Feextube With Tire Lever

BM14-PATCH-SET

- Includes** 1 x Feextube (3 x self-adhesive patches, 1 x tire boot), 3 x tire levers.

### Feextube Spare Part

BM09-PO-AFT-01-K

- Functions** Supplement package for Feextube (BM09-PO-AFT-91-K).
- Includes** 6 x self-adhesives patches, 2 x tire boots.



NEW

### Tubeless Tire Lever Set

BM19-WG-K-SET (3pcs/set)

- Functions**
- Designed specifically to make mounting tight and stubborn tires a less painful experience.
  - For use on both tubeless and tubed tires.
  - Clips onto the rim to help hold the mounted parts of the tire bead in place.
  - Concurred edge fits snugly with the rim, enabling better engagement with the tire bead, and easier tire removal.
  - Thin edge slips under the tire bead easily, especially handy when there is a tight space between tire bead and rim.

**Material** Glass-fiber reinforced high polymer

**Size** 120 x 27 x 6mm

**Weight** 16g (1pcs)

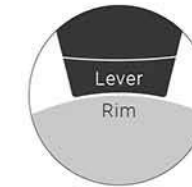

Concurve edge

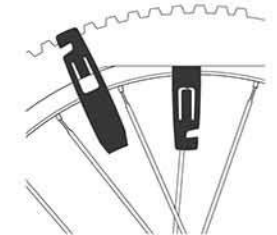

Rim clip

NEW

### Tubeless Repair Kit

BM19-TUBL-RE-KIT

- Functions**
- Puncture repair kit in the shape of a CO2 cartridge (including threads) with enhanced portability.
  - Contents include an insertion tool / cleaning file and 5 pcs x 2 sets tire plugs.

**Material** CNC machined aluminium / Stainless steel

**Size** Ø23 x 87.5mm

**Weight** 44g

Assemble in place of a standard cartridge for a puncture repair and CO2 inflation solution.

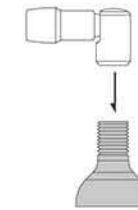

Thread carries CO2 valve head in transit.



Bundle strap

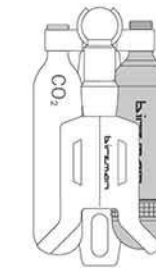

CO2 mount  
Uncage Repair Kit  
(BM17-UNCAGE-RP-KIT)

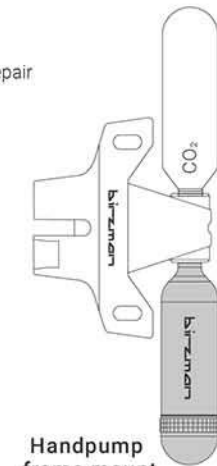

Handpump frame mount



NEW

### Tire Plugs

BM19-TIRE-PLUG3550

- Functions** Supplement package (5 pcs x 5 sets) for use with a Birzman insertion tool / cleaning file.

**Size** Ø3.5 x 50mm

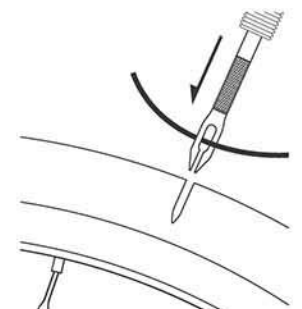





*Slowly  
and  
incrementally*

Wheel & Spoke Tools



**NEW**

**Wheel Truing Stand Universal**

BM19-WHTS

- Functions**
- Designed for Road, MTB and Fat Bikes.
  - Lengthened and strengthened uprights fit wheels up to 29" with or without a tire.
  - Compatible with hub widths up to 235mm (with Upright Extensions)
  - Interchangeable pointer bits, accepting rim widths from 19-105mm (4").
  - Sturdy turning dials of comfortable grip.
  - Spring-loaded callipers enable symmetric adjustments of calliper arms.
  - Ultimate accuracy.

**Material** SPHC / Aluminium / Alloy steel / High polymer (pointer)



**Dial Indicator Gauge**

BM15-WHTS-GAUGE

- Functions**
- Measures the lateral and radial run-out of wheels to 0.01mm.
  - Mounts easily onto Birzman's Wheel Truing Stand.

**Material** Aluminium / Alloy steel / High polymer



Upright Extensions



Calliper Upgrade Kit

**Truing Stand Adapter Set**

BM17-WHTS-ADAPTER

- Functions**
- Upright Extensions + Calliper Upgrade Kit.
  - For use with Birzman Truing Stand. (BM15-WHTS)
  - Upright extensions increase the hub compatibility up to 235mm.
  - New calliper design with interchangeable pointer bits allow greater rim compatibility range of 19-105mm.
  - Accepts tire widths up to 5".

**Material** SPHC / Aluminium / Alloy steel / High polymer (pointer)



**Truing Stand Calibration Gauge**

BM17-WHTS-CAL-GAUGE

- Functions**
- Acts as a replicate of a perfectly dished wheel, used to inspect and realign the uprights of a truing stand.

**Material** SUS304 Stainless steel

**Size** 310 x 141 x 3mm





## Spoke Wrenches

**Material** CNC machined 7075-T6 aluminium, sandblasted then anodised to indicate individual sizes.



### Black 3.23

BM16-SW-B323  
For 0.127" (3.23mm) nipples.



### Green 3.3

BM16-SW-GN33  
For 0.130" (3.30mm) nipples.



### Red 3.45

BM16-SW-RD345  
For 0.136" (3.45mm) nipples.



### Gold 3.96

BM16-SW-GD396  
For 0.156" (3.96mm) nipples.

*When a pop of colour is completely necessary.*



## Spoke Wrench

BM12-ST-ABV07-K

**Functions** - Compatible with 12-15G and Shimano® 4.3/4.4mm spoke nipples.  
- Features a hex hole in the center.

**Material** CrMo



## Bladed Spoke Grip

BM16-BL-SP-G

**Functions** Compatible with 1.0-2.0mm wide bladed spokes.

**Material** High polymer  
**Size** 65 x 45 x 20mm



## Spoke Tension Meter

BM15-ABV-METER

**Functions** - Mitutoyo® dial indicator.  
- Scales to 0.01mm.  
- Compatible with wheels from 18" and up.  
- Wear-resistant measuring posts.

**Material** CNC machined aluminium / CrMo / Alloy steel



## Wheel Alignment Gauge

BM15-WH-GAUGE

**Functions** - Checks the dish on 16" to 29" wheels.  
- Features sliding blocks applicable with tire on the wheel.

**Material** Aluminium / Alloy steel / High polymer



## Rotational Nipple Screwdriver

BM17-RO-NI-SD

**Functions** Compatible with rims up to 45mm deep.

**Material** CrMo steel / High polymer

**Size** 180 x 35mm



## Internal Nipple Spoke Wrench

**3.2mm Square** BM16-SW32  
**5.5mm Hex** BM16-SW55  
**3/16" Hex** BM16-SW163

**Functions** Offers a 140mm long reach for deep section rims.

**Material** CrMo / High polymer

**Size** 160 x 85mm



## Spoke Ruler

BM16-SP-RU

**Functions** - Measures up to 310mm/12.2".  
- Features embossed markings.

**Ball bearings** 1/8", 3/32", 1/16", 7/32", 1/4"

**Spoke diameters** Ø1.6-Ø4.4

**Material** Stainless steel

## Hub & Axles Tools



## Cone Wrench

**13 mm** BM16-CW13  
**15 mm** BM16-CW15  
**17 mm** BM16-CW17  
**19 mm** BM16-CW19

**Material** SPHC / High polymer

**Width** 2mm

**Size** 210mm



## Hub Tools

**13 mm** BM10-ST-HB11-K13  
**14 mm** BM10-ST-HB12-K14  
**15 mm** BM10-ST-HB13-K15  
**16 mm** BM10-ST-HB14-K16  
**17 mm** BM10-ST-HB15-K17  
**18 mm** BM10-ST-HB16-K18  
**19 mm** BM10-ST-HB17-K19  
**20 mm** BM10-ST-HB18-K20  
**22 mm** BM10-ST-HB19-K22

**Functions** Features an ergonomically designed bending angle.

**Material** SPHC / High polymer

**Width** 2.4mm

**Size** 240-260mm



## Axle and Spindle Vise Insert

BM15-AX-VISE

**Functions** - Ø 5/9/10/12/15/21/25/36mm, 17-21 hex jaw openings.  
- Features built-in magnets to hold the Insert in place during bench vise use.  
- Compatible with axles, spindles, hydraulic hoses, and Birzman Lockring sockets.

**Material** CNC machined aluminium





**8mm Hex Bit Socket**

BM08-RWH-HBS08

**Functions** | 1/2" Dr.  
**Material** | Alloy steel / CrV (bits)



**NEW**  
**T30 Hex Bit Socket**

BM19-SOCKET-T30

**Functions** | 1/2" Dr.  
**Material** | Alloy steel / CrV (bits)



**14mm Hex Socket**

BM14-RWH-HBS14

**Functions** | 1/2" Dr.  
**Material** | Alloy steel



**15mm Hex Socket**

BM14-RWH-HBS15

**Functions** | 1/2" Dr.  
**Material** | Alloy steel



**Socket Wrench**

BM14-SW-K

**Functions** | For use with 1/2" Dr. sockets.  
**Material** | Hardened steel / TPR  
**Size** | 12"



**Shifting Spanner**

BM13-SS

**Functions** | - Jaw opens up to 33mm.  
- Features a laser engraved measurement scale.  
**Material** | Hardened Steel / High polymer  
**Size** | 10"



**File**

BM14-FILE-K

**Functions** | Half-round file.  
**Material** | 65Mn / High polymer  
**Size** | 6"



**File II**

BM17-FILE-K

**Functions** | Half-round file with anti-slip handle.  
**Material** | 65Mn / High polymer  
**Size** | 7"



**Radio Pliers**

BM14-RP-K

**Functions** | - Five different crimping zones, including a crimper for cable end caps.  
- Features a forming hole for reforming housing ends and ferrules.  
**Material** | Hardened Steel / High polymer  
**Size** | 6"



**Diagonal Pliers**

BM14-DP-K

**Material** | Hardened Steel / High polymer  
**Size** | 6"



**Combination Wrench**

BM14-HCW-S

**Functions** | Double-ended, 8/10mm.  
**Material** | CrV  
**Size** | 5.5"



**15mm Combination Wrench**

BM18-CW-GT15

**Functions** | Features a ratcheting open end with angled edges, and a ratcheting box end with 72-teeth.  
**Material** | CNC machined CrV / TPR  
**Size** | 6.5"



**Dead Blow Hammer**

BM13-DH

**Functions** | - Anti-slip rubber grip.  
- Oil-resistant and cold tolerant.  
**Material** | NBR / TPV  
**Size** | 12"



**Screwdriver Set**

BM14-SD-SET

**Cross head** | 80mm (#1) / 100mm (#2)  
**Flathead** | 5.5 x 100mm  
**Material** | CrMo / High polymer



**O-Ring Pick**

BM15-ORING-P

**Functions** | - Hooked- and L-shaped ends.  
- N- and spoon- shaped ends.  
**Material** | Hardened Steel / High polymer



**Tape Measure**

BM13-ATM-K

**Functions** | - Sturdy, composite housing.  
- Metric and Imperial readings up to 3m/10ft in length.  
**Material** | Stainless steel / High polymer

**Protections**



**Frame and Crank Protector**

BM09-PO-FCP-01

**Functions** | - Transparent.  
- For use on down tubes, head tubes, seat tubes and cranks.  
**Material** | TPU



**Chain Stay Protector**

**Road frames** | BM12-PO-CSP02-RB  
**MTB frames** | BM12-PO-CSP02-MB  
**Material** | TPU



**Spiral Housing Covers**

BM16-SHC (4pcs/Set)

**Functions** | - Protect frames from housing scratches.  
- Compatible with  $\varnothing 3$  to 5mm housings.  
**Material** | Silicone



**Tube Tops Housing Covers**

**4mm** | BM16-TTHC-4 (4pcs/set)  
**5mm** | BM16-TTHC-5 (4pcs/set)  
**Functions** | - Protect frames from housing scratches.  
- Slide over housings easily.  
**Material** | Silicone



**Cable Cocoon**

BM17-CABL-COCOON (6pcs/set)

**Functions** | - Provides shelter for surplus cable ends to prevent interference with surrounding parts.  
- Covers frayed ends as temporary protection from deterioration and prevents injury upon contact.

**Includes** | Derailleur Cable :  $\varnothing 1.2$ mm/3pcs  
Brake Cable :  $\varnothing 1.5$ mm/3pcs  
**Material** | High polymer



**Pulley Shield**

BM17-PO-PULLEY-SH

**Functions** | Protects rear derailleur from direct collision and interfering with spokes.  
**Material** | High polymer

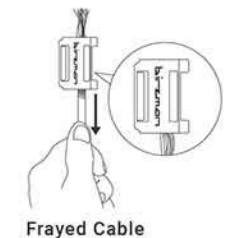

Frayed Cable



Cantilever Brakes/  
Derailleur

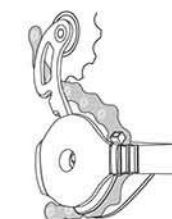





### Travel Keeper (Front)

BM10-TR-FCK-01-K

- Functions**
- Maintains fork tension when the wheel is removed.
  - Features a quick release lever.
  - Compatible with front dropouts with a span of 100mm.

**Material** Aluminium / Stainless steel

**Includes** 1 x Disc Brake Pad Spacer



### Travel Keeper (Rear)

BM09-PO-ACK-01-K

- Functions**
- Maintains chain tension when the wheel is removed.
  - Features a quick release lever.
  - Compatible with rear dropouts with a span of 130/135mm.

**Material** Aluminium / Stainless steel

**Includes** 1 x Disc Brake Pad Spacer



### Chain Keeper

BM17-CHAIN-KEEPER

- Functions**
- Keeps the chain in place when the wheel is removed.
  - Features a quick release lever.

**Material** Silicone / Aluminium

**Size** 85 x 40 x 11mm

## Cleaning & Lubrications



### Chain Cleaning Set

BM12-ST-CHC01-SET

- Includes**
- Chain and Freewheel Cleaner
  - Chain Scrubber 120ml
  - Chain Lubricant 120ml



### Grease Gun with Lubrication Grease

BM14-LGG-S

- Functions** | Controls for precise amounts of Birzman Lubrication Grease.



### Lubrication Grease 100ML

BM14-LG-100ML

- Functions**
- Protects against corrosion, heat, and water.
  - Ideal for hubs, screws, nuts, bolts, bearings, and bottom brackets.

**Temperature tolerance** -20°C ~ 180°C / -4°F ~ 356°F

**Volume** 100ml / 3.5oz

**Contains** Copper, graphite and silicon.



### Anti Slip Compound

120ml (4o.z.) | BM16-CBC-120  
5ml (0.17o.z.) | BM14-CBC-5 (50pcs/box)

- Functions**
- Increases friction and reduces fastening torque by up to 30%.
  - Specifically designed for carbon fiber & aluminium seat posts, seat tubes, handle bars, and stems.



### Magic Oil

M12-ST-MGC02-12PCS (12 bottles/box)

- Functions**
- Multi-purpose maintenance and cleaning oil.
  - Cleans stubborn stains, removes rust, lubricates and acts as an anti-rust agent.
  - Non-flammable and high temperature resistance.
  - CFC free with no awful or pungent smell.

**Volume** 150ml / 5o.z

## Workstations



### 3 Drawer Workbench

BM08-WB-3D

- Functions**
- 3 ball bearing drawers.
  - Perforated back panel with 10 hangers (4 single, 4 double & 2 U-shaped).
  - Birzman workstands can be attached and fixed onto the workbench.

**Material** SPHC steel

**Size** L70 x W100 x H156cm



Double Single U-Shaped



### Mobile Cart-1

BM14-MC-6D

- Functions**
- 6 ball bearing drawers (4 small, 1 medium & 1 large).
  - 12 plastic inner compartments.
  - Perforated back panels with 10 single hangers.
  - Side panel.
  - Heavy-duty casters (2 fixed & 2 swivel).

**Material** SPHC steel

**Size** L46 x W68 x H81cm

## Storage



### Magnetic Collector

BM15-MAG-C

- Functions** | Retains small parts to promote quicker access.

**Material** Stainless steel

**Size** 6"



NEW

### 1/2" Dr. Socket Holder with Magnetic Panel

BM19-MAG-H

- Functions**
- Features 7pcs of 1/2" Dr. Socket Holders.
  - Equipped with a Magnetic Panel for attachment onto metallic surfaces.

**Material** Aluminium / High Polymer

**Size** 340 x 28 x 25mm

## Others



### Workshop Apron

BM10-RO-AWA-01-K

- Functions** | 4 pockets including one with zip.

**Size** 80 x 58cm



NEW

### Workshop Apron II

BM17-RO-AWA-01-GN

- Functions** | 3 pockets

**Material** 420D/600D high density fabric

**Size** 80 x 58cm





**be  
boundless.**